



ALBIO 135

THERMAL BREAK OPENING ENTRANCE

ΣΥΣΤΗΜΑ ΕΙΣΟΔΟΥ ΜΕ ΘΕΡΜΟΔΙΑΚΟΠΗ

Σύστημα εισόδου με θερμοδιακοπή, κατάλληλο για κατασκευές υψηλών προδιαγραφών με πάνελ ή υαλοπίνακες σε πληθώρα τυπολογιών. Το σύστημα ALBIO 135 λόγω της στιβαροτητάς του είναι κατάλληλο για εφαρμογή όπου απαιτείται καθημερινή συχνή χρήση όπως σε μονοκατοικίες, πολυκατοικίες και δημόσια κτήρια. Παράλληλα παρέχει υψηλή θερμομόνωση, ηχομόνωση στεγάνωση και αισθητική. Συνδυάζει το διαχρονικό σχεδιασμό με τη σύγχρονη τεχνολογία και το άρτιο αισθητικά αποτέλεσμα με τα υψηλά standards κατασκευής.

ENTRANCE SYSTEM WITH THERMAL-BREAK

Entrance system with thermal-break, suitable for high specifications constructions in a variety of typologies with panels or glass panes. ALBIO 135 due to its robust design is suitable for applications where daily frequent usage is required like in houses, block of flats and public buildings. Simultaneously it provides high thermal, sound and water insulation in combination with an aesthetic design. The system combines classic design with new technology, as well as fine aesthetics with high construction standards.

ΠΕΡΙΕΧΟΜΕΝΑ TABLE OF CONTENTS

ΣΥΝΟΠΤΙΚΟΣ ΠΙΝΑΚΑΣ / SUMMARY.....	3
ΠΡΟΦΙΛ / PROFILES	5
ΤΥΠΟΛΟΓΙΑ / TYPOLOGY.....	14
ΤΟΜΕΣ / SECTIONS.....	15
ΕΞΑΡΤΗΜΑΤΑ / ACCESSORIES.....	39
ΟΔΗΓΙΕΣ ΚΟΠΗΣ / CUTTING INSTRUCTIONS.....	43



LICENCE Nr: 106



Qualanod

LICENCE Nr: 1503







**AUSTRIA
HELLAS**

ISO 9001:2008
ISO 14001:2004
OHSAS 18001:2008
CE/ EN 15088:2005

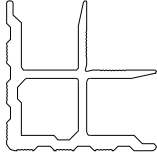
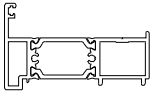

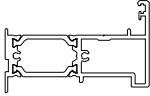
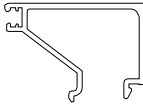
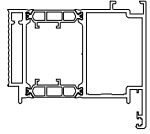
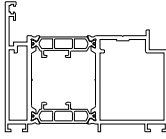
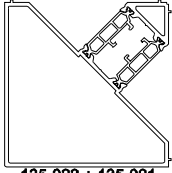
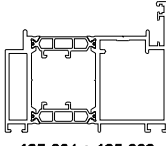
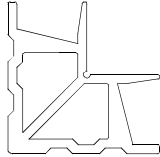
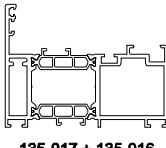
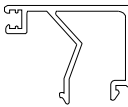
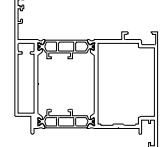

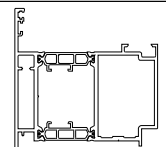
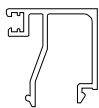
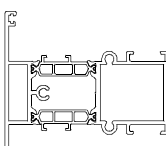
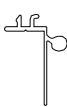
ΣΥΝΟΠΤΙΚΟΣ ΠΙΝΑΚΑΣ / SUMMARY

ΠΡΟΦΙΛ PROFILES	ΣΧΗΜΑ DRAWING	ΒΑΡΟΣ / ΜΗΚΟΣ WEIGHT / LENGTH	ΒΕΡΤΕΣ / ΔΕΜΑ BARS / BUNDLE	ΠΡΟΦΙΛ PROFILES	ΣΧΗΜΑ DRAWING	ΒΑΡΟΣ / ΜΗΚΟΣ WEIGHT / LENGTH	ΒΕΡΤΕΣ / ΔΕΜΑ BARS / BUNDLE
135-014		5272 gr/m 6 m	2	135-210	 135-010 + 135-009	1541 gr/m 4,6 m	2
135-015		248 gr/m 6 m	10	135-212	 135-012 + 135-011	1537 gr/m 4,6 m	2
135-020		395 gr/m 6 m	12	135-213	 135-013 + 135-005	2244 gr/m 6 m	2
135-202	 135-002 + 135-001	2282 gr/m 6 m	2	135-222	 135-022 + 135-021	2449 gr/m 6 m	2
135-204	 135-004 + 135-003	2320 gr/m 6 m	2	101-072		3613 gr/m 5 m	1
135-205	 135-017 + 135-016	2128 gr/m 6 m	2	101-078A		391 gr/m 6 m	12
135-206	 135-006 + 135-005	2643 gr/m 6 m	2	101-080		283 gr/m 6 m	15
135-208	 135-008 + 135-007	2602 gr/m 6 m	2	101-083A		338 gr/m 6 m	12
135-209	 135-019 + 135-018	2315 gr/m 6 m	2	101-149		143 gr/m 6 m	16

06/2013

ΣΥΝΟΠΤΙΚΟΣ ΠΙΝΑΚΑΣ / SUMMARY

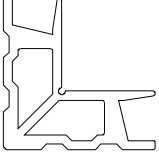
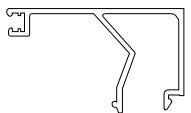
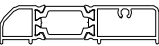
ΠΡΟΦΙΛ PROFILES	ΣΧΗΜΑ DRAWING	ΒΑΡΟΣ / ΜΗΚΟΣ WEIGHT / LENGTH	ΒΕΡΤΕΣ / ΔΕΜΑ BARS / BUNDLE	ΠΡΟΦΙΛ PROFILES	ΣΧΗΜΑ DRAWING	ΒΑΡΟΣ / ΜΗΚΟΣ WEIGHT / LENGTH	ΒΕΡΤΕΣ / ΔΕΜΑ BARS / BUNDLE
101-150		281 gr/m 6 m	16				
101-166		99 gr/m 6 m	20				
109-030		3397 gr/m 5 m	2				
109-148		460 gr/m 6 m	12				
109-413		815 gr/m 6 m	8				

06/2013

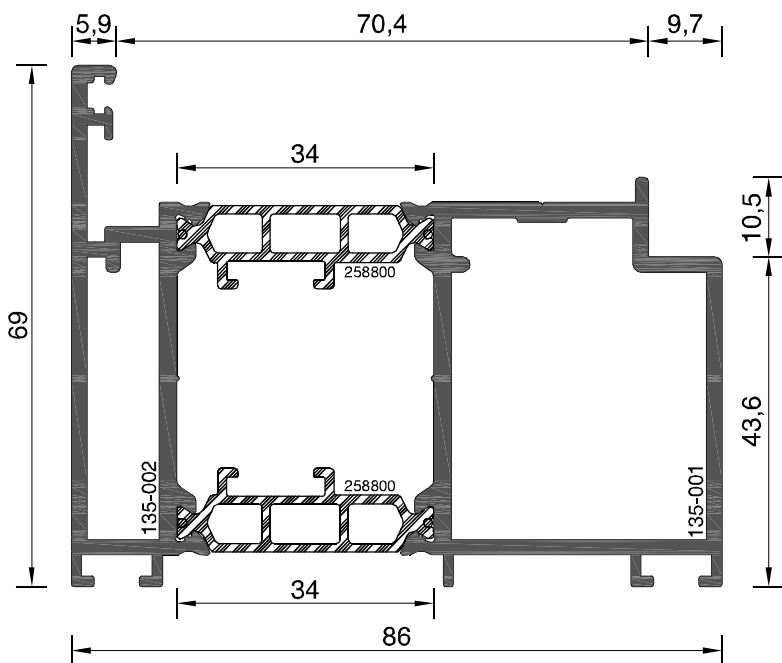

ΚΑΣΑ ΕΙΣΟΔΟΥ (Ανοιγόμενη εσωτερικά)
Door frame profile (Inward opening)

135-202

ΒΑΡΟΣ / Weight

2282 gr/m

ΓΩΝΙΕΣ ΓΩΝΙΑΣΤΡΑΣ ΣΕ ΕΞΑΡΤΗΜΑ
Machine pressed joint corners

ΕΞΩΤΕΡΙΚΗ External	ΕΣΩΤΕΡΙΚΗ Internal
135-002 (4350)	135-001 (4349)

ΠΡΟΦΙΛ ΓΙΑ ΚΟΠΗ ΓΩΝΙΩΝ ΓΩΝΙΑΣΤΡΑΣ : **101-072**
Machine pressed joint corner profil : **101-072**

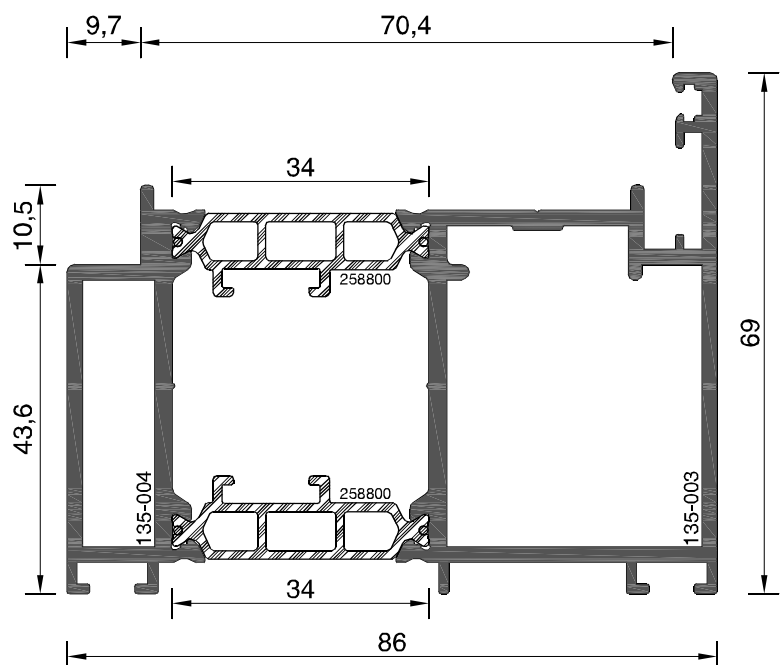

ΚΑΣΑ ΕΙΣΟΔΟΥ (Ανοιγόμενη εξωτερικά)
Door frame profile (Outward opening)

135-204

ΒΑΡΟΣ / Weight

2320 gr/m

ΓΩΝΙΕΣ ΓΩΝΙΑΣΤΡΑΣ ΣΕ ΕΞΑΡΤΗΜΑ
Machine pressed joint corners

ΕΞΩΤΕΡΙΚΗ External	ΕΣΩΤΕΡΙΚΗ Internal
135-001 (4349)	135-002 (4350)

ΠΡΟΦΙΛ ΓΙΑ ΚΟΠΗ ΓΩΝΙΩΝ ΓΩΝΙΑΣΤΡΑΣ : **101-072**
Machine pressed joint corner profil : **101-072**

Κλίμακα / scale = 1 : 1

06/2013

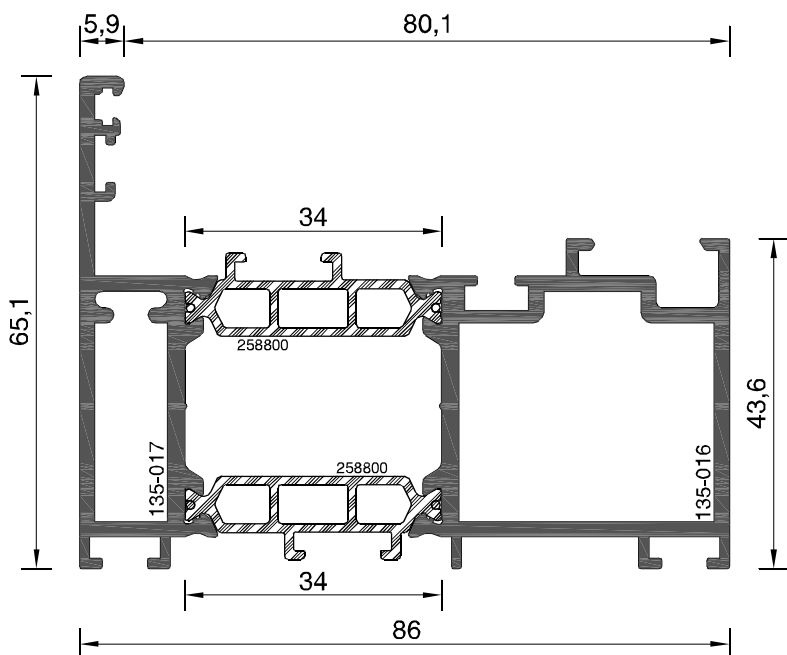

ΚΑΣΑ
Frame profile

135-205
ΒΑΡΟΣ / Weight
2128 gr/m

ΓΩΝΙΕΣ ΓΩΝΙΑΣΤΡΑΣ ΣΕ ΕΞΑΡΤΗΜΑ Machine pressed joint corners	
ΕΞΩΤΕΡΙΚΗ External	ΕΣΩΤΕΡΙΚΗ Internal
000-000 (0000)	109-011 (5755)

ΠΡΟΦΙΛ ΓΙΑ ΚΟΠΗ ΓΩΝΙΩΝ ΓΩΝΙΑΣΤΡΑΣ : **109-030**
Machine pressed joint corner profil : **109-030**

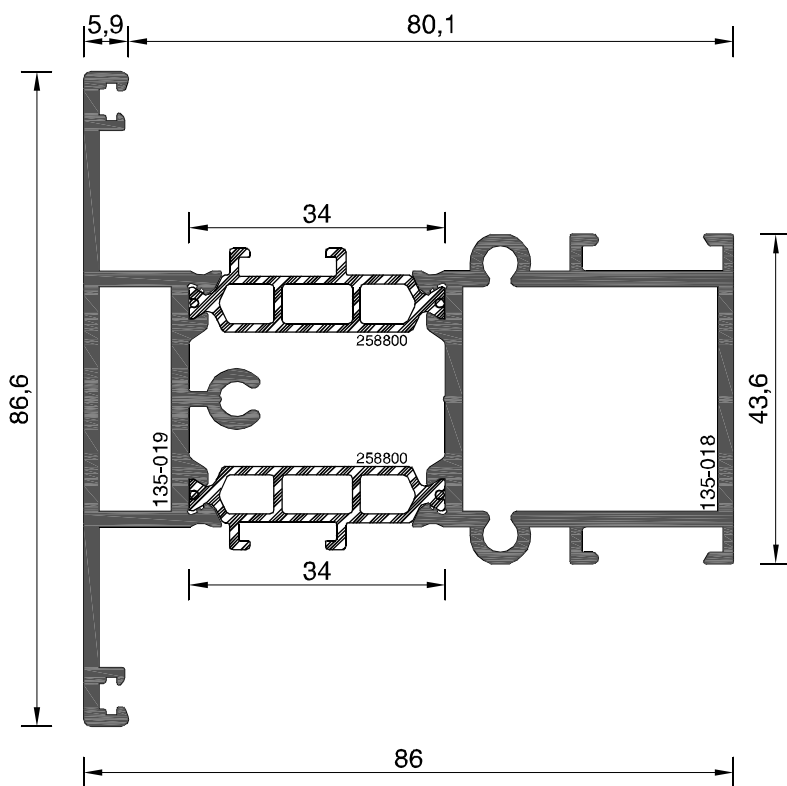

"T" ΠΡΟΦΙΛ
"T" profile

135-209
ΒΑΡΟΣ / Weight
2315 gr/m

--

Κλίμακα / scale = 1 : 1

06/2013

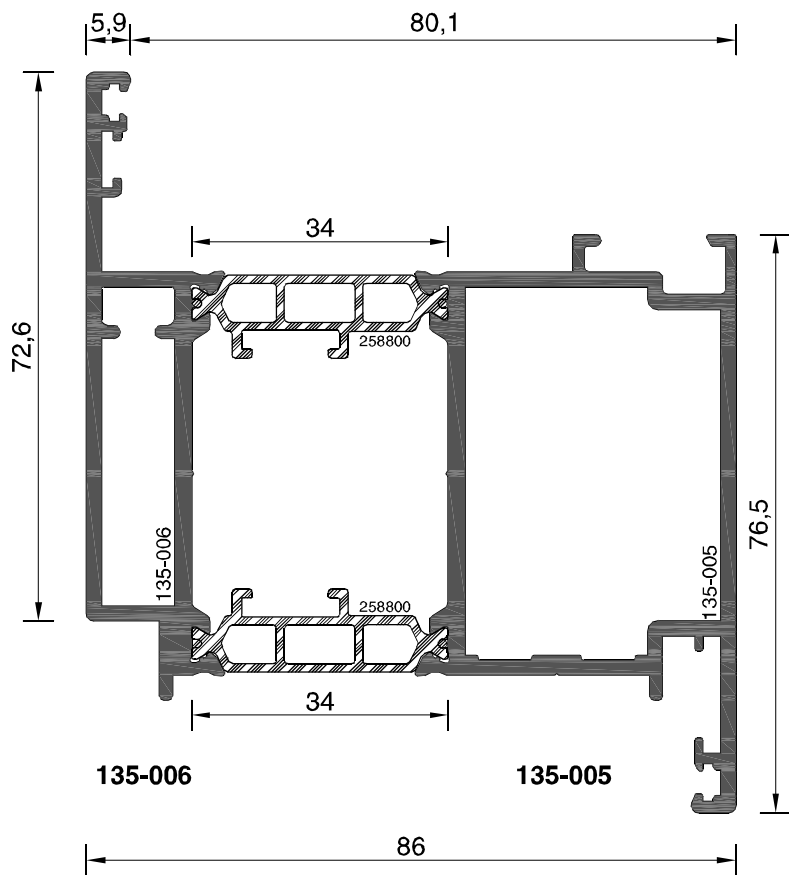

ΦΥΛΛΟ ΕΙΣΟΔΟΥ (Ανοιγόμενη εσωτερικά)
Door sash profile (Inward opening)

135-206

ΒΑΡΟΣ / Weight

2643 gr/m

ΓΩΝΙΕΣ ΓΩΝΙΑΣΤΡΑΣ ΣΕ ΕΞΑΡΤΗΜΑ
Machine pressed joint corners

ΕΞΩΤΕΡΙΚΗ
External

135-002 (4350)

ΕΣΩΤΕΡΙΚΗ
Internal

135-005 (4351)

ΠΡΟΦΙΛ ΓΙΑ ΚΟΠΗ ΓΩΝΙΩΝ ΓΩΝΙΑΣΤΡΑΣ :
101-072, 135-014
Machine pressed joint corner profil :
101-072, 135-014

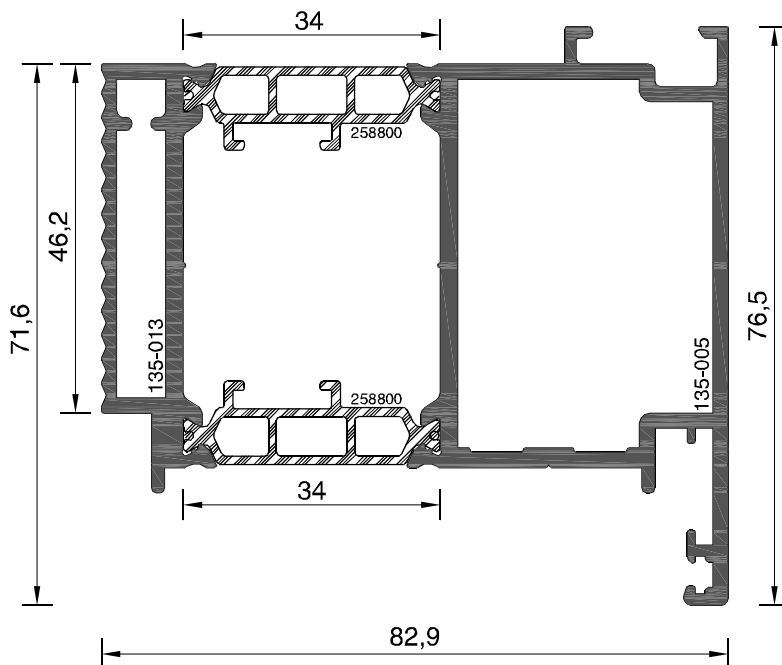

ΦΥΛΛΟ ΕΙΣΟΔΟΥ (Ανοιγόμενη εσωτερικά)
Door sash profile (Inward opening)

135-213

ΒΑΡΟΣ / Weight

2244 gr/m

ΓΩΝΙΕΣ ΓΩΝΙΑΣΤΡΑΣ ΣΕ ΕΞΑΡΤΗΜΑ
Machine pressed joint corners

ΕΞΩΤΕΡΙΚΗ
External

000-000 (0000)

ΕΣΩΤΕΡΙΚΗ
Internal

135-005 (4351)

ΠΡΟΦΙΛ ΓΙΑ ΚΟΠΗ ΓΩΝΙΩΝ ΓΩΝΙΑΣΤΡΑΣ :
101-072, 135-014
Machine pressed joint corner profil :
101-072, 135-014

Κλίμακα / scale = 1 : 1

06/2013

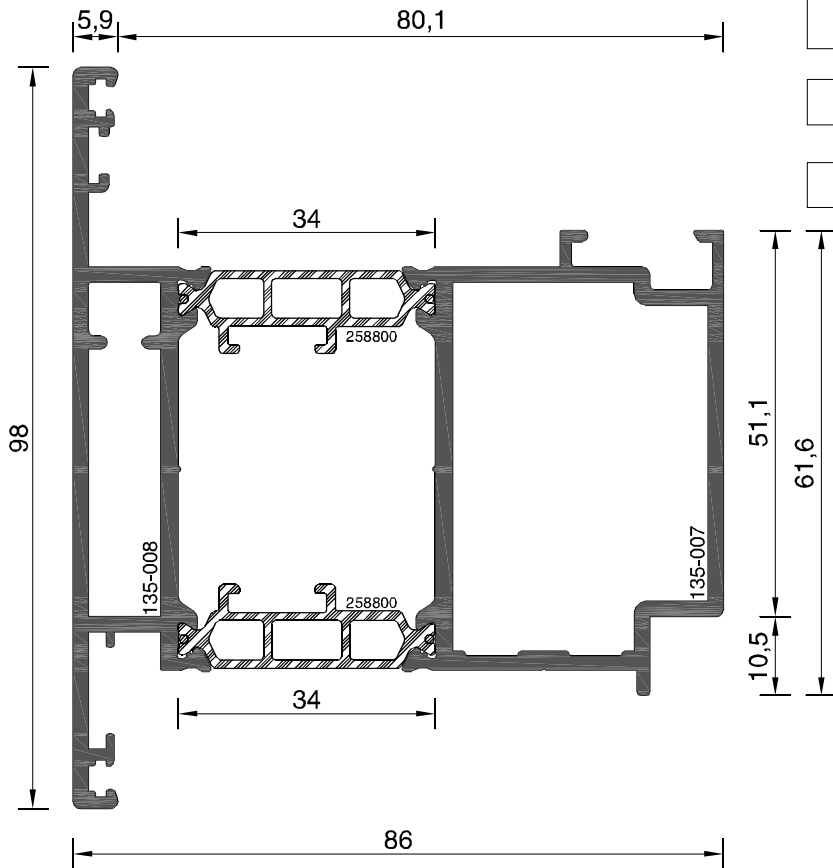

ΦΥΛΛΟ ΕΙΣΟΔΟΥ (Ανοιγόμενη εξωτερικά)
Door sash profile (Outward opening)

135-208

ΒΑΡΟΣ / Weight

2602 gr/m

ΓΩΝΙΕΣ ΓΩΝΙΑΣΤΡΑΣ ΣΕ ΕΞΑΡΤΗΜΑ
Machine pressed joint corners

ΕΞΩΤΕΡΙΚΗ
External

135-002 (4350)

ΕΣΩΤΕΡΙΚΗ
Internal

135-005 (4351)

ΠΡΟΦΙΛ ΓΙΑ ΚΟΠΗ ΓΩΝΙΩΝ ΓΩΝΙΑΣΤΡΑΣ :
101-072, 135-014
Machine pressed joint corner profil :
101-072, 135-014

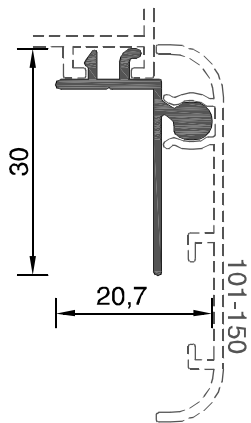

ΠΡΟΦΙΛ ΓΙΑ ΚΛΙΠ ΣΥΓΚΡΑΤΗΣΗΣ ΑΡΜΟΚΑΛΥΠΤΡΟΥ 101-150
Clip for cover profile 101-150

101-149

ΒΑΡΟΣ / Weight

143 gr/m

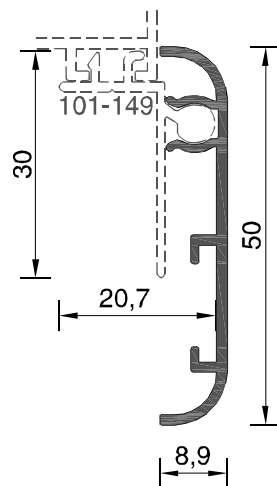

ΑΡΜΟΚΑΛΥΠΤΡΟ
Cover gap

101-150

ΒΑΡΟΣ / Weight

281 gr/m

Κλίμακα / scale = 1 : 1

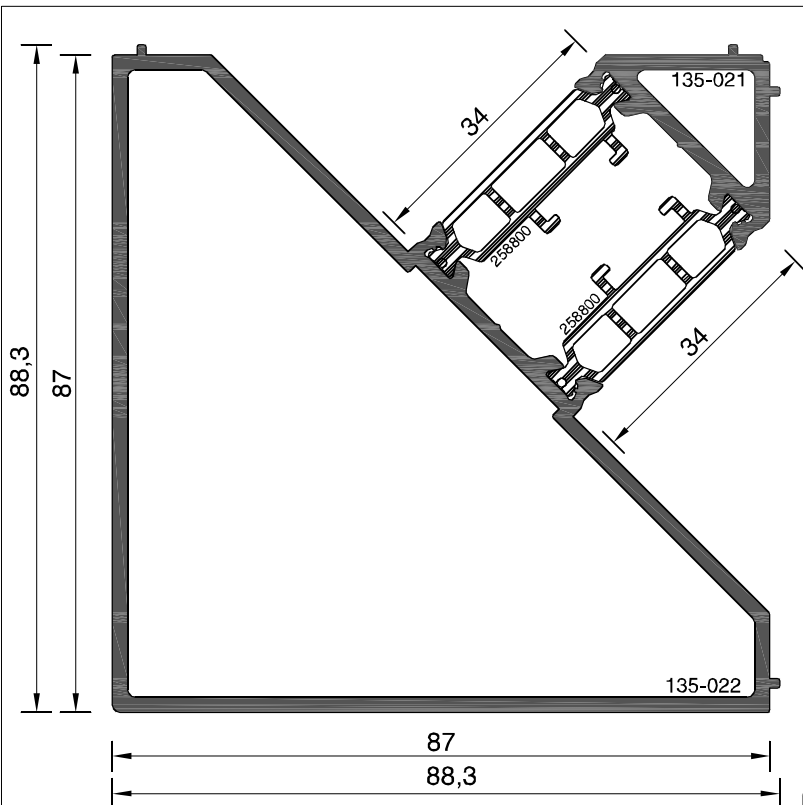

ΚΟΛΩΝΑ 90°
Mullion 90°

135-222

ΒΑΡΟΣ / Weight

2449 gr/m



ΠΡΟΦΙΛ ΕΝΩΣΗΣ ΚΑΣΑΣ ΜΕ ΚΑΣΑ
Frame coupling profile

101-166

ΒΑΡΟΣ / Weight

99 gr/m

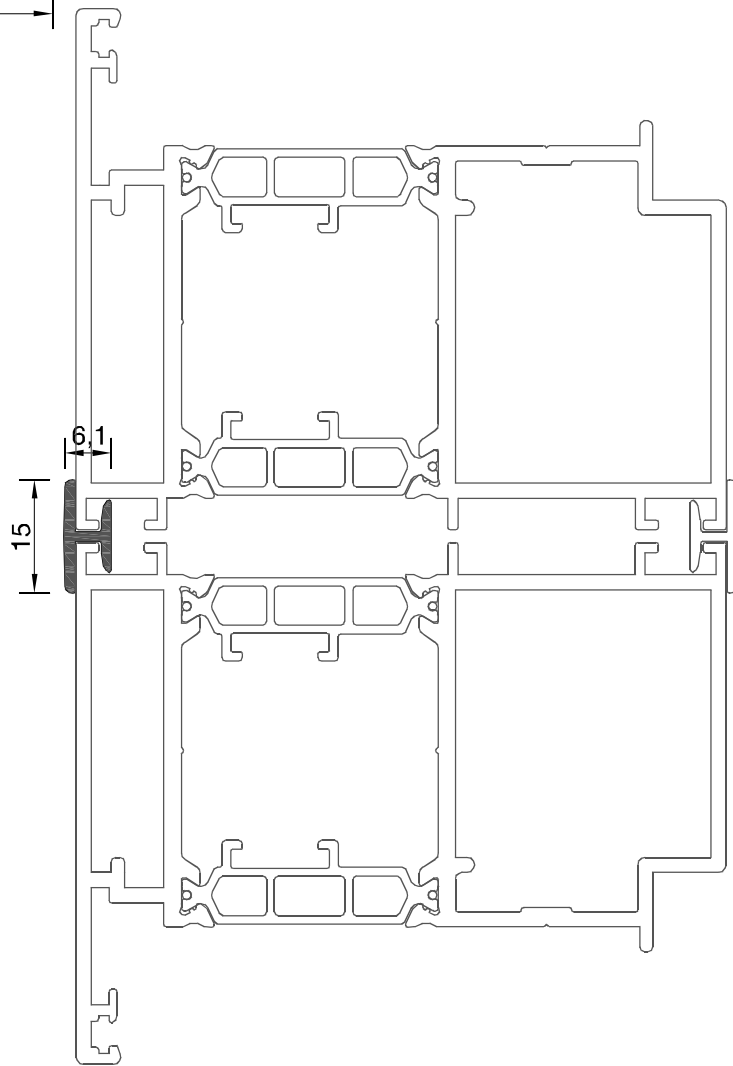

Κλίμακα / scale = 1 : 1

06/2013

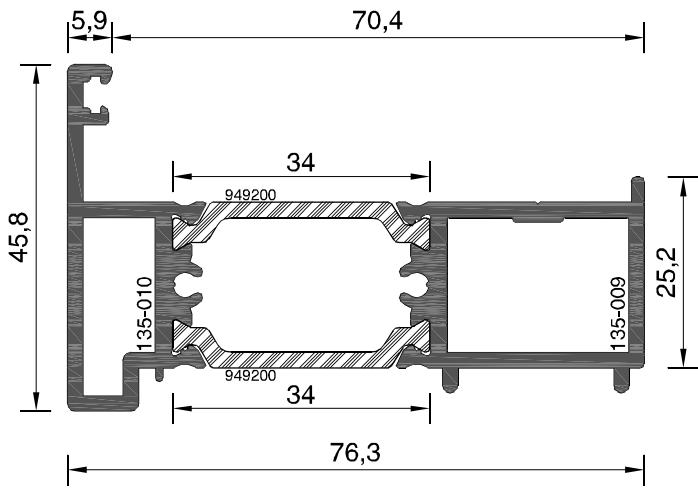

ΜΠΙΝΙ ΕΙΣΟΔΟΥ (Ανοιγόμενη εσωτερικά)
Door rabbet profile (Inward opening)

135-210
ΒΑΡΟΣ / Weight
1541 gr/m

**ΣΥΝΕΡΓΑΖΕΤΑΙ ΜΕ ΤΗΝ ΤΑΠΑ ΜΠΙΝΙ
135-210 (0000)
Assembled with rabbet seal plug
135-210 (0000)**

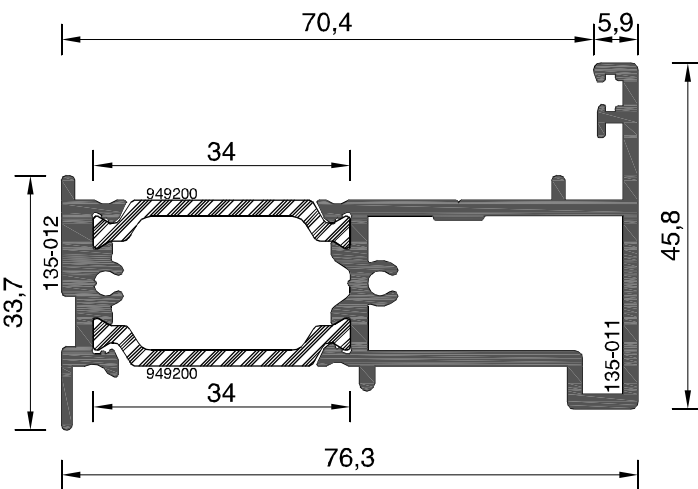

ΜΠΙΝΙ ΕΙΣΟΔΟΥ (Ανοιγόμενη εξωτερικά)
Door rabbet profile (Outward opening)

135-212
ΒΑΡΟΣ / Weight
1537 gr/m

**ΣΥΝΕΡΓΑΖΕΤΑΙ ΜΕ ΤΗΝ ΤΑΠΑ ΜΠΙΝΙ
135-212 (0000)
Assembled with rabbet seal plug
135-212 (0000)**

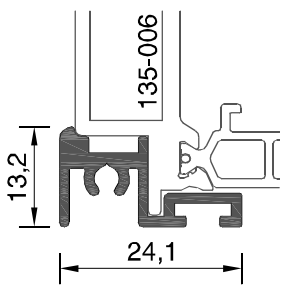

ΝΕΡΟΧΥΤΗΣ
Draining hole

135-015
ΒΑΡΟΣ / Weight
248 gr/m

**ΣΥΝΕΡΓΑΖΕΤΑΙ ΜΕ ΤΗΝ ΤΑΠΑ
ΝΕΡΟΧΥΤΗ 135-015 (4352) (ΖΕΥΓΟΣ)
Assembled with rabbet seal plug
draining hole 135-015 (4352)**

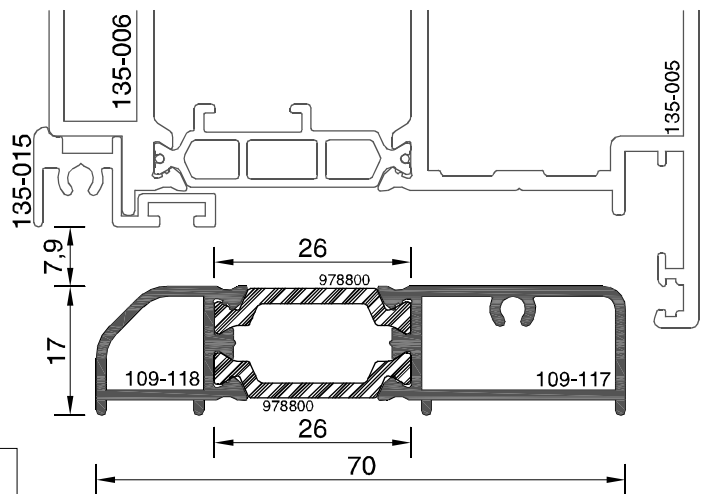

ΚΑΤΩΚΑΣΙ
Threshold

109-413
ΒΑΡΟΣ / Weight
815 gr/m

Κλίμακα / scale = 1 : 1

ΠΗΧΑΚΙΑ ΓΙΑ PANEL 40 - 50 - 60 mm
GLAZING BEADS FOR 40 - 50 - 60 mm PANELS

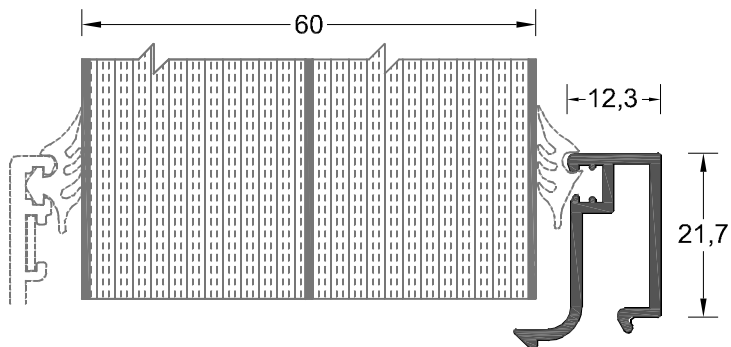

ΠΗΧΑΚΙ ΙΣΙΟ
 Glazing bead flat

101-080

ΒΑΡΟΣ / Weight
283 gr/m

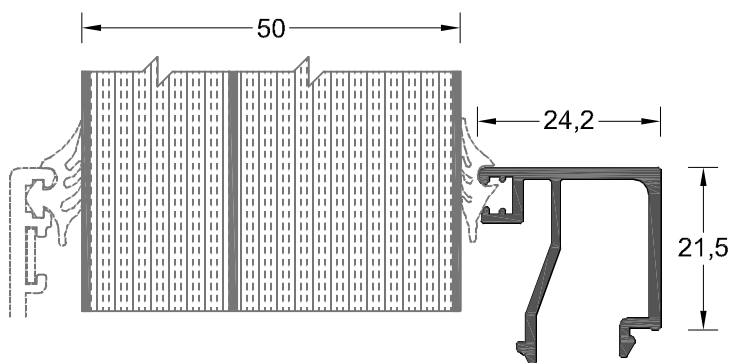

ΠΗΧΑΚΙ ΙΣΙΟ
 Glazing bead flat

101-083A

ΒΑΡΟΣ / Weight
338 gr/m

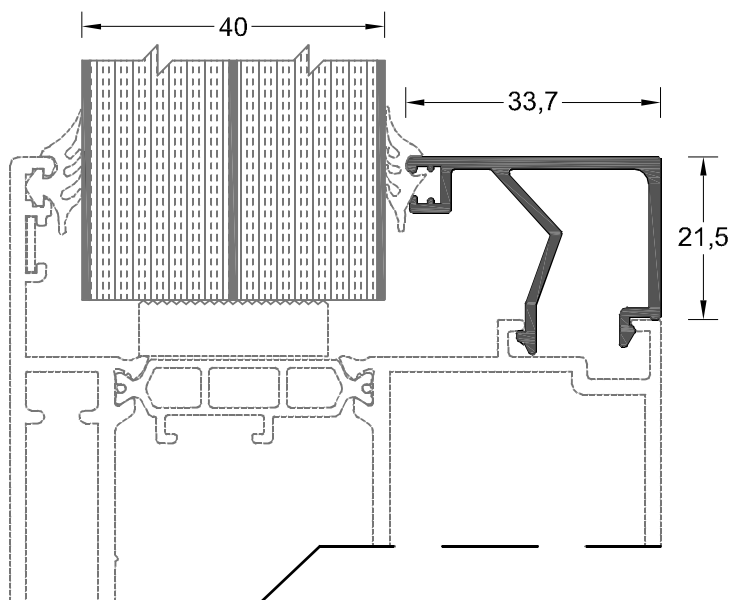

ΠΗΧΑΚΙ ΙΣΙΟ
 Glazing bead flat

101-078A

ΒΑΡΟΣ / Weight
391 gr/m

Κλίμακα / scale = 1 : 1

06/2013

ΠΗΧΑΚΙΑ ΓΙΑ ΚΟΛΛΗΤΑ PANEL 47 mm
GLAZING BEADS FOR GLUED PANELS 47mm

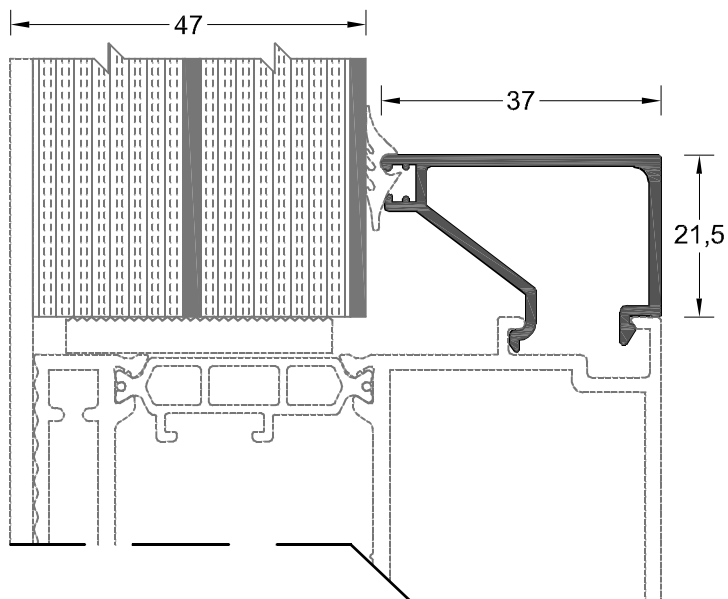

ΠΗΧΑΚΙ ΙΣΙΟ
 Glazing bead flat

135-020

ΒΑΡΟΣ / Weight

395 gr/m

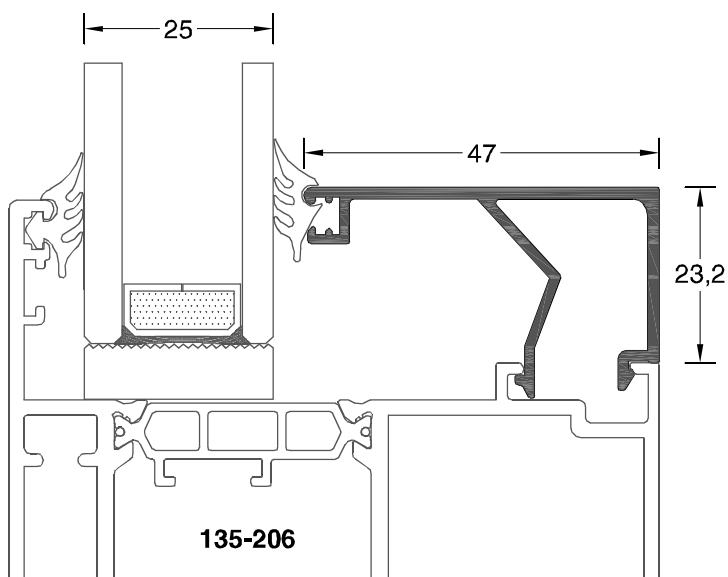

ΠΗΧΑΚΙ ΙΣΙΟ
 Glazing bead flat

109-148

ΒΑΡΟΣ / Weight

460 gr/m

135-206

Κλίμακα / scale = 1 : 1

ΠΡΟΦΙΛ ΓΙΑ ΚΟΠΗ ΓΩΝΙΩΝ ΓΩΝΙΑΣΤΡΑΣ
MACHINE PRESSED JOINT CORNER PROFILES

101-072

ΒΑΡΟΣ / Weight

3613 gr/m

ΚΑΤΑΛΛΗΛΟ ΓΙΑ ΓΩΝΙΕΣ ΓΩΝΙΑΣΤΡΑΣ:
 For machine pressed joint corners:

135-001	135-002
---------	---------

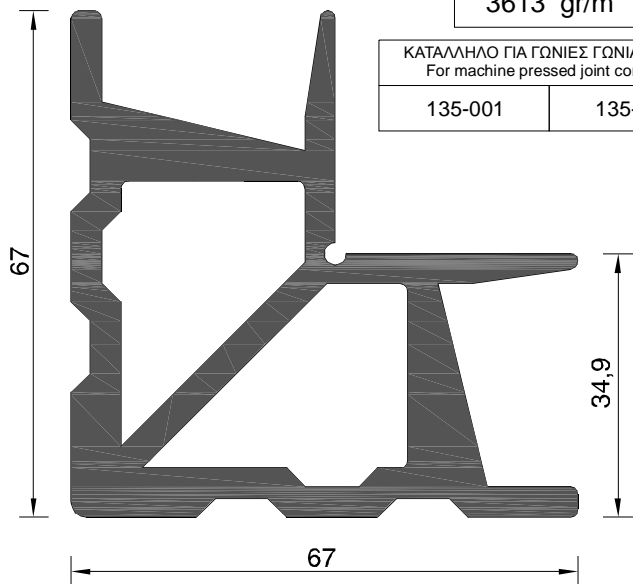

109-030

ΒΑΡΟΣ / Weight

3397 gr/m

ΚΑΤΑΛΛΗΛΟ ΓΙΑ ΓΩΝΙΕΣ ΓΩΝΙΑΣΤΡΑΣ:
 For machine pressed joint corners:

109-011

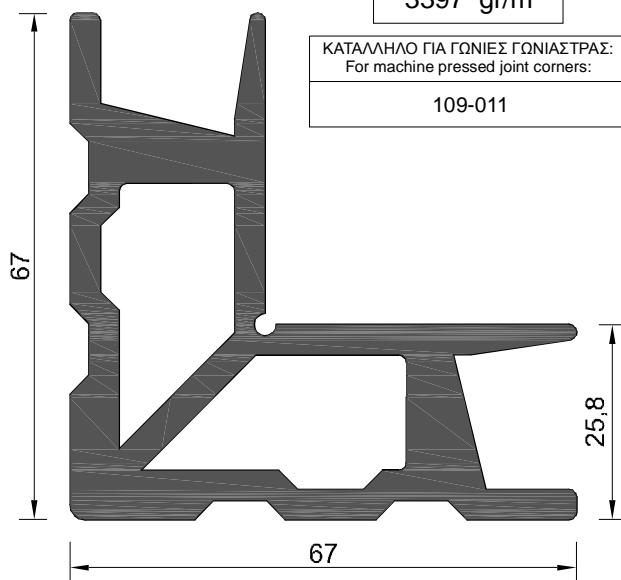

135-014

ΒΑΡΟΣ / Weight

5272 gr/m

ΚΑΤΑΛΛΗΛΟ ΓΙΑ ΓΩΝΙΕΣ ΓΩΝΙΑΣΤΡΑΣ:
 For machine pressed joint corners:

135-005

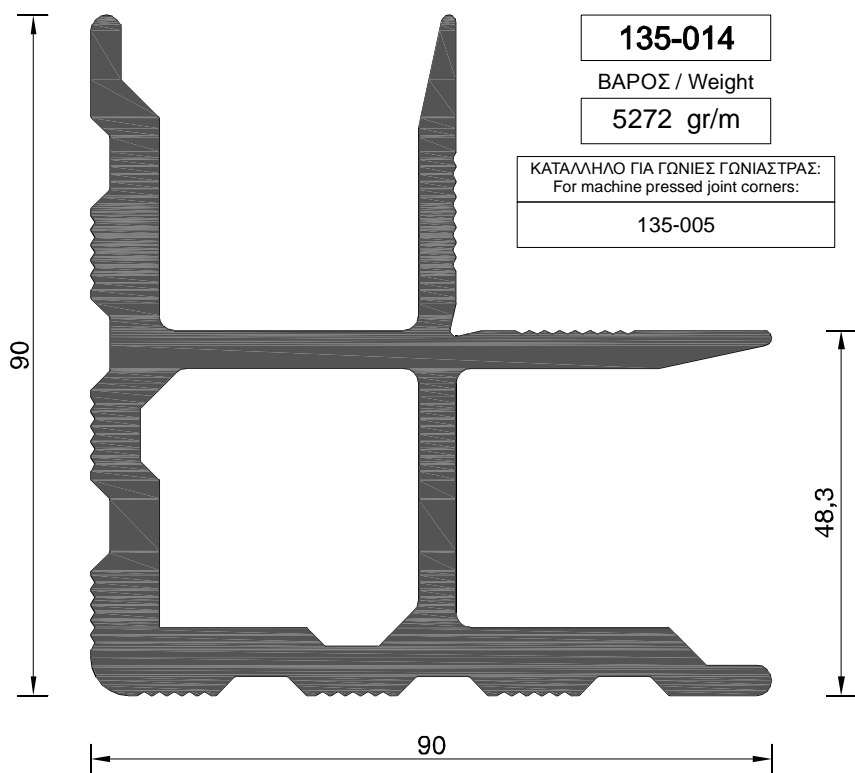

Κλίμακα / scale = 1 : 1

06/2013

ΕΙΣΟΔΟΣ ΜΟΝΟΦΥΛΛΗ ΑΝΟΙΓΟΜΕΝΗ ΠΡΟΣ ΤΑ ΜΕΣΑ (PANEL 40mm)
SINGLE-SASH INWARDS OPENING ENTRANCE

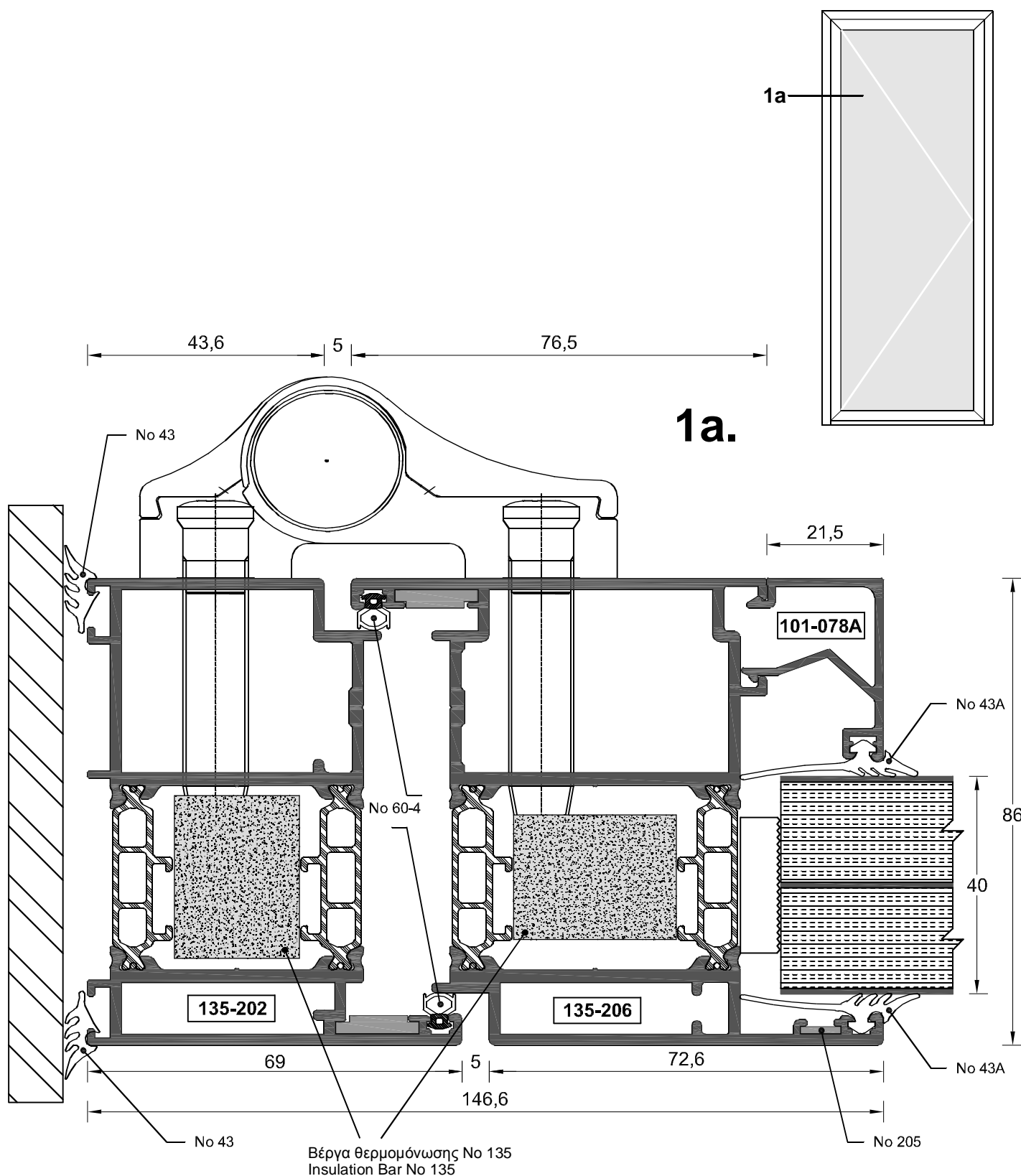

Κλίμακα / scale = 1 : 1

ΕΙΣΟΔΟΣ ΜΟΝΟΦΥΛΛΗ ΑΝΟΙΓΟΜΕΝΗ ΠΡΟΣ ΤΑ ΜΕΣΑ (PANEL 50mm)
SINGLE-SASH INWARDS OPENING ENTRANCE

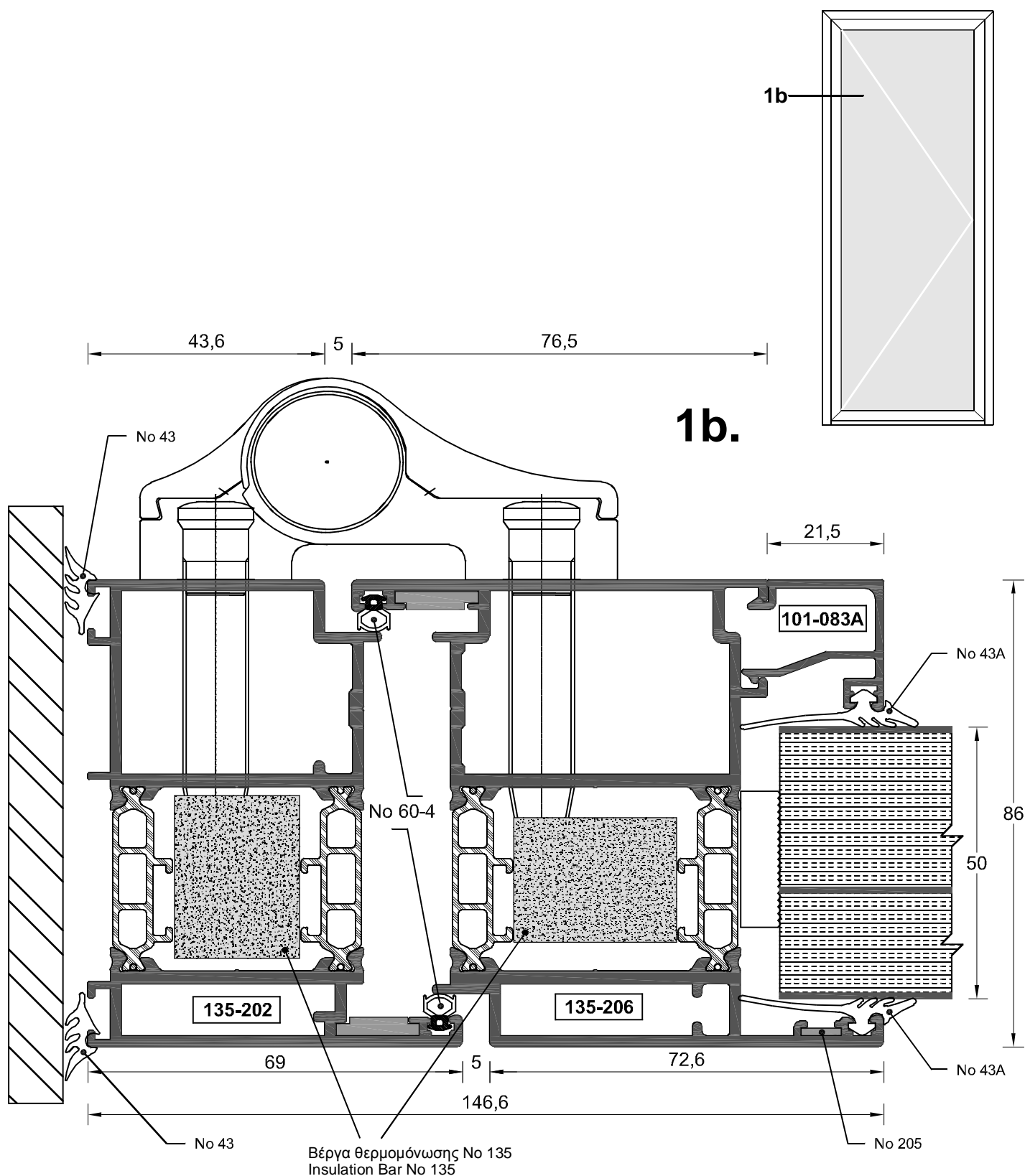

ΕΙΣΟΔΟΣ ΜΟΝΟΦΥΛΛΗ ΑΝΟΙΓΟΜΕΝΗ ΠΡΟΣ ΤΑ ΜΕΣΑ (PANEL 60mm)
SINGLE-SASH INWARDS OPENING ENTRANCE

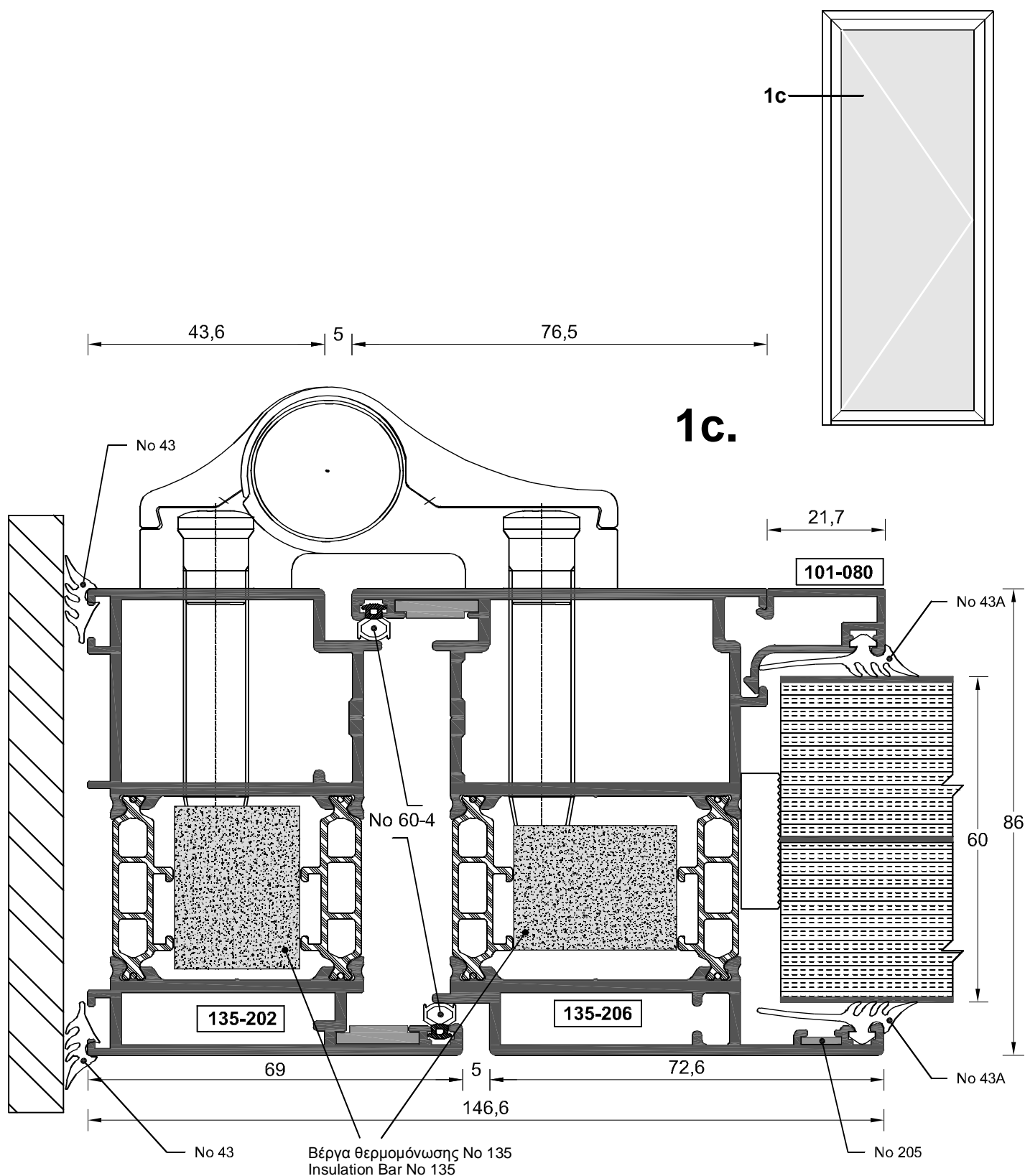

Κλίμακα / scale = 1 : 1

ΕΙΣΟΔΟΣ ΜΟΝΟΦΥΛΛΗ ΑΝΟΙΓΟΜΕΝΗ ΠΡΟΣ ΤΑ ΜΕΣΑ (PANEL 40mm)
SINGLE-SASH INWARDS OPENING ENTRANCE

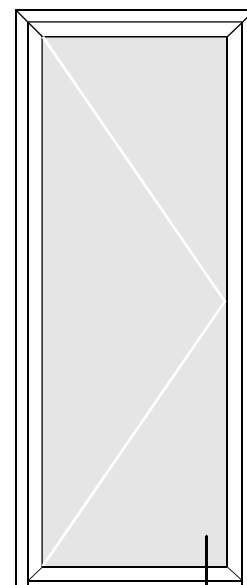
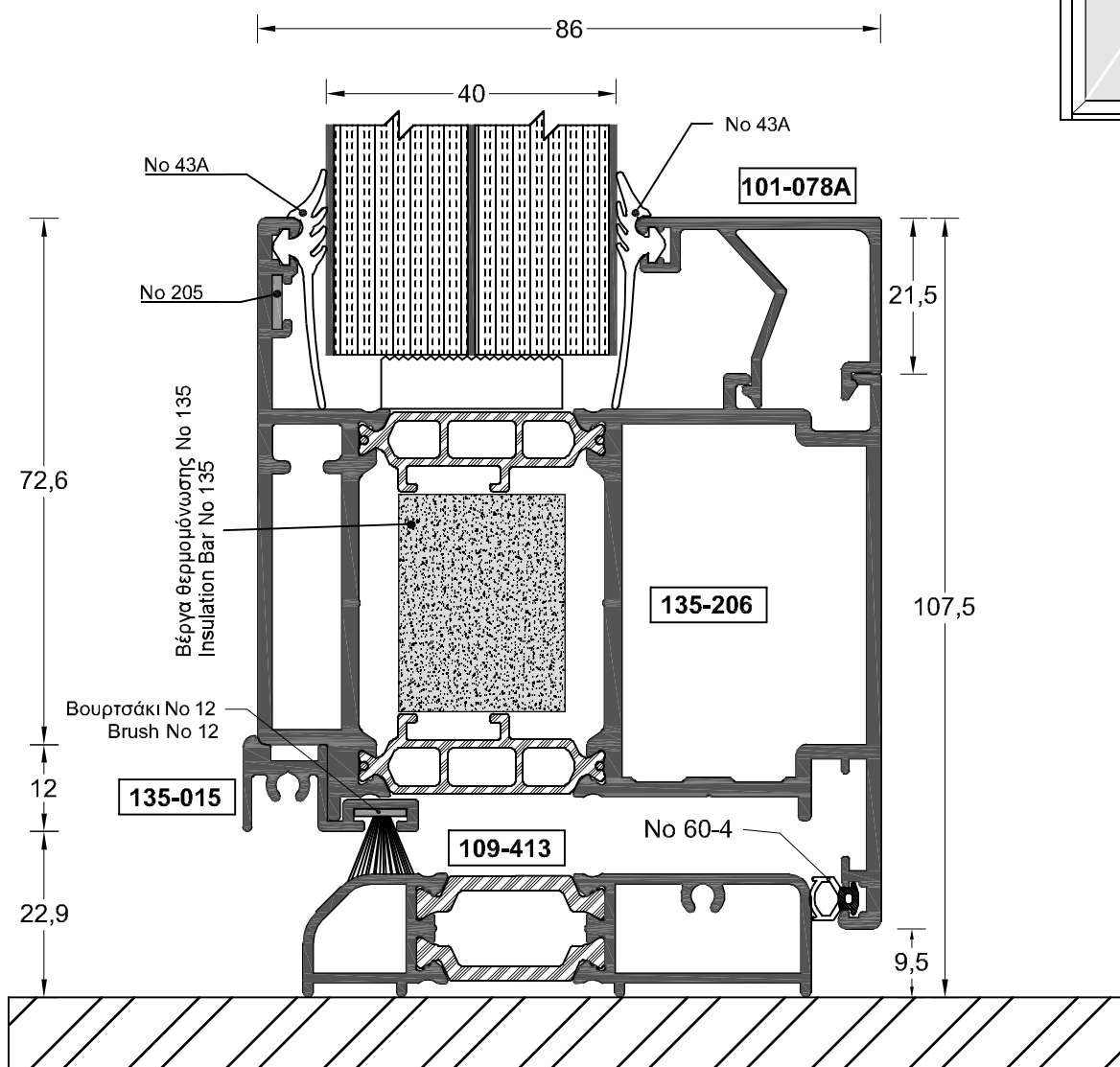

1d

1d.

Κλίμακα / scale = 1 : 1

**ΕΙΣΟΔΟΣ ΔΙΦΥΛΛΗ ΑΝΟΙΓΟΜΕΝΗ ΠΡΟΣ ΤΑ ΜΕΣΑ (PANEL 40mm)
DOUBLE-SASH INWARDS OPENING ENTRANCE**

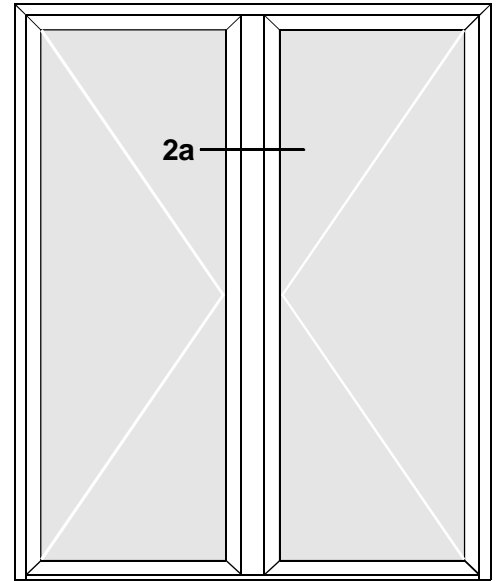
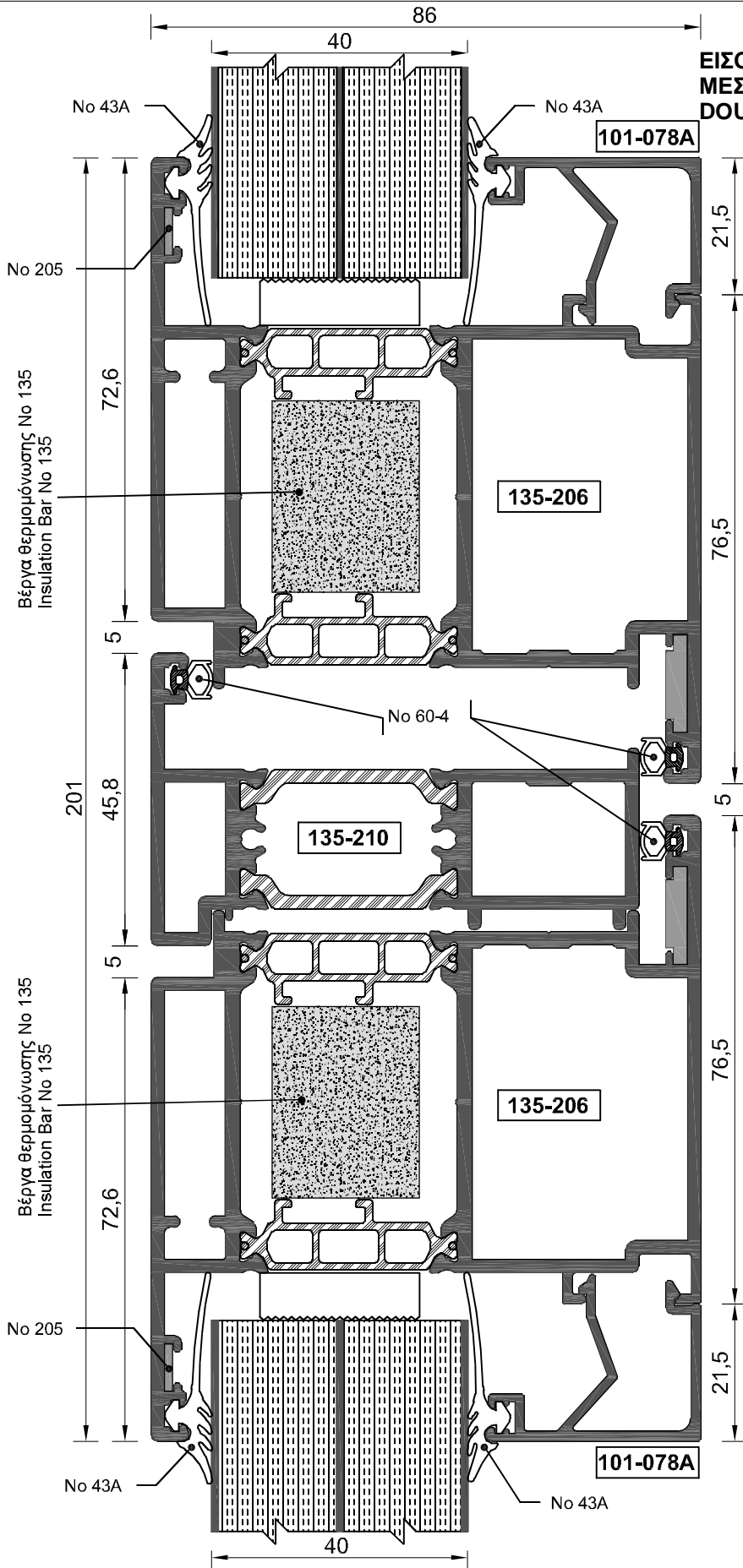

2a.

Κλίμακα / scale = 1 : 1

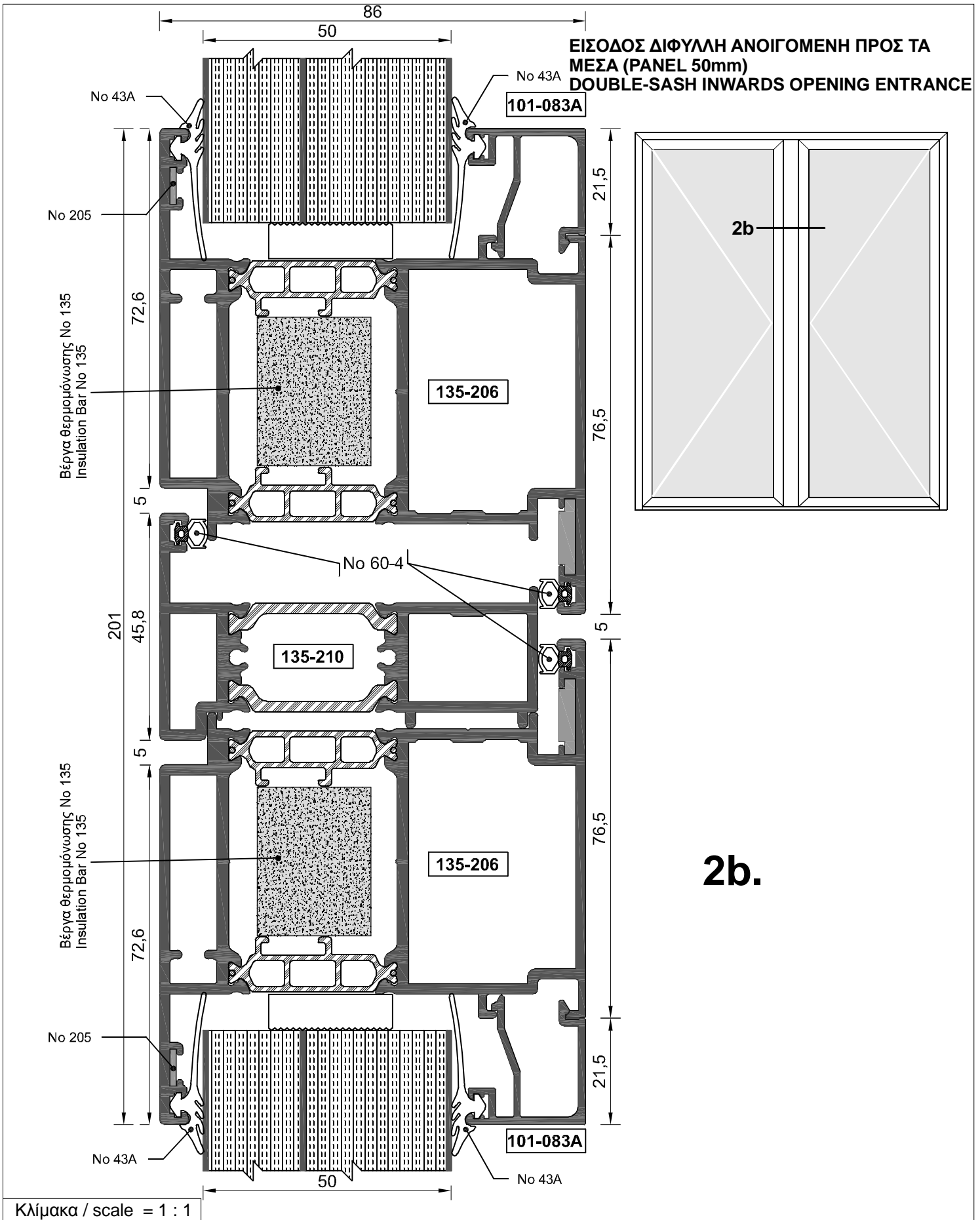

**ΕΙΣΟΔΟΣ ΔΙΦΥΛΛΗ ΑΝΟΙΓΟΜΕΝΗ ΠΡΟΣ ΤΑ ΜΕΣΑ (PANEL 60mm)
DOUBLE-SASH INWARDS OPENING ENTRANCE**

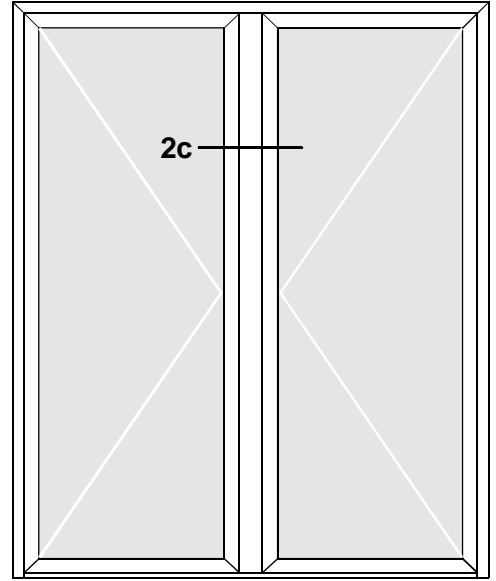
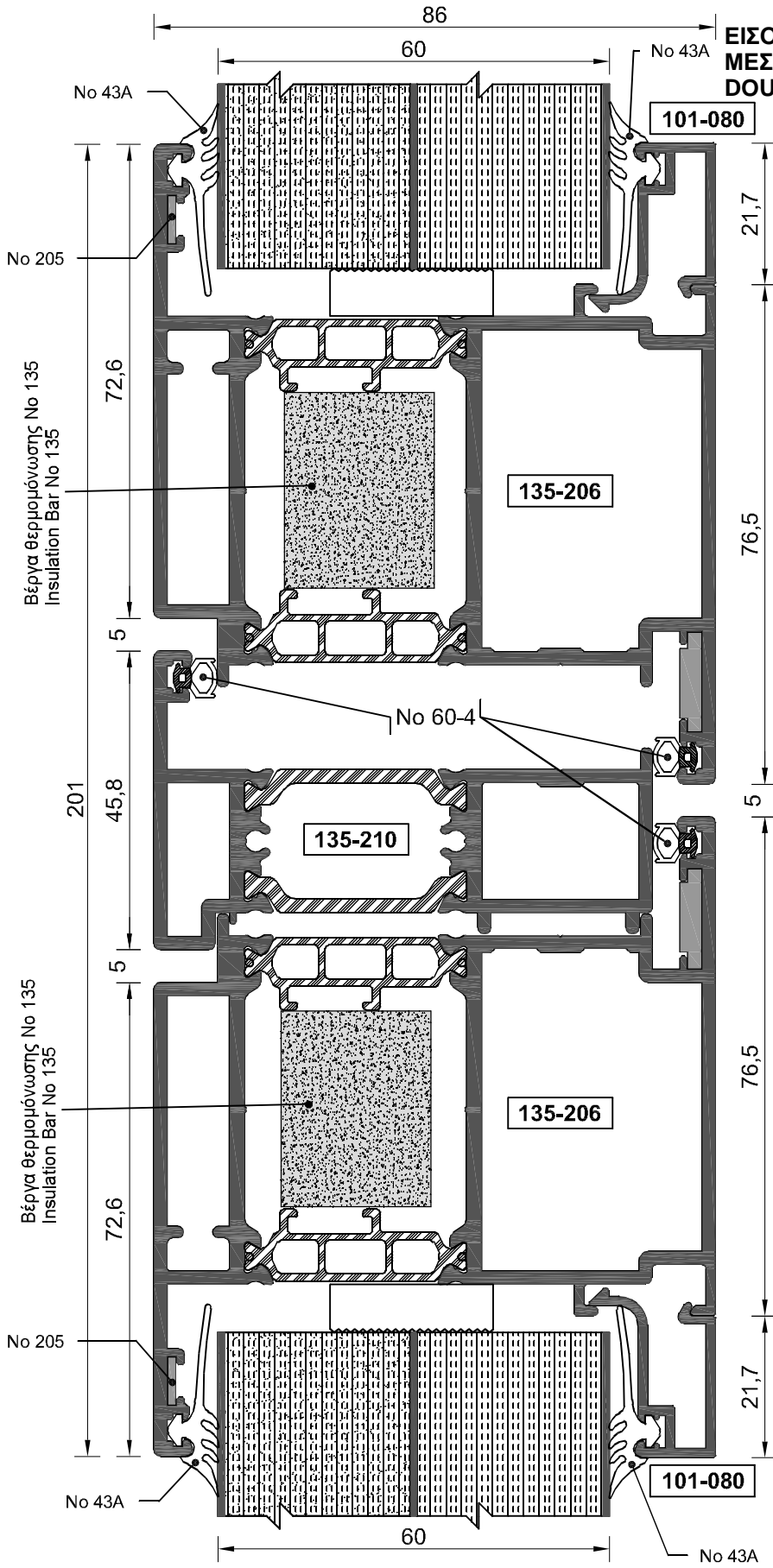

2c.

Κλίμακα / scale = 1 : 1

ΕΙΣΟΔΟΣ ΜΟΝΟΦΥΛΛΗ ΑΝΟΙΓΟΜΕΝΗ ΠΡΟΣ ΤΑ ΕΞΩ (PANEL 40mm)
SINGLE-SASH OUTWARDS OPENING ENTRANCE

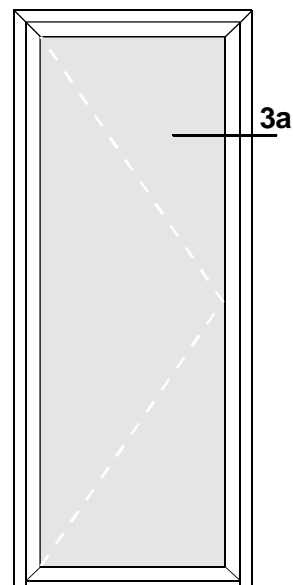

3a.

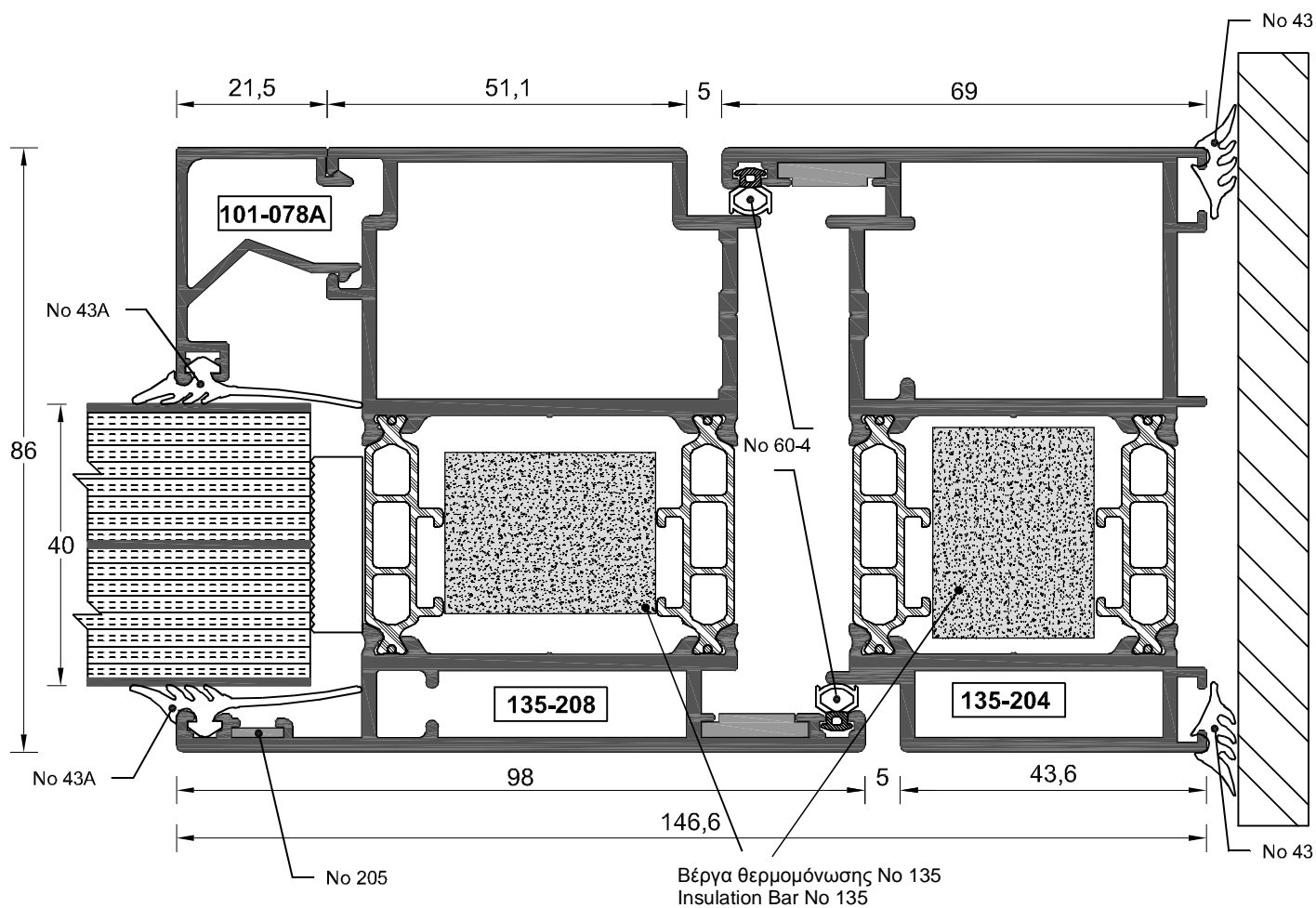

Κλίμακα / scale = 1 : 1

ΕΙΣΟΔΟΣ ΜΟΝΟΦΥΛΛΗ ΑΝΟΙΓΟΜΕΝΗ ΠΡΟΣ ΤΑ ΕΞΩ (PANEL 50mm)
SINGLE-SASH OUTWARDS OPENING ENTRANCE

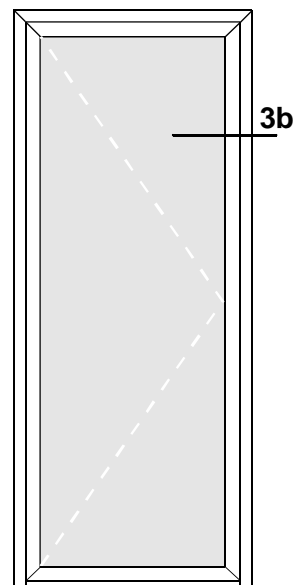

3b.

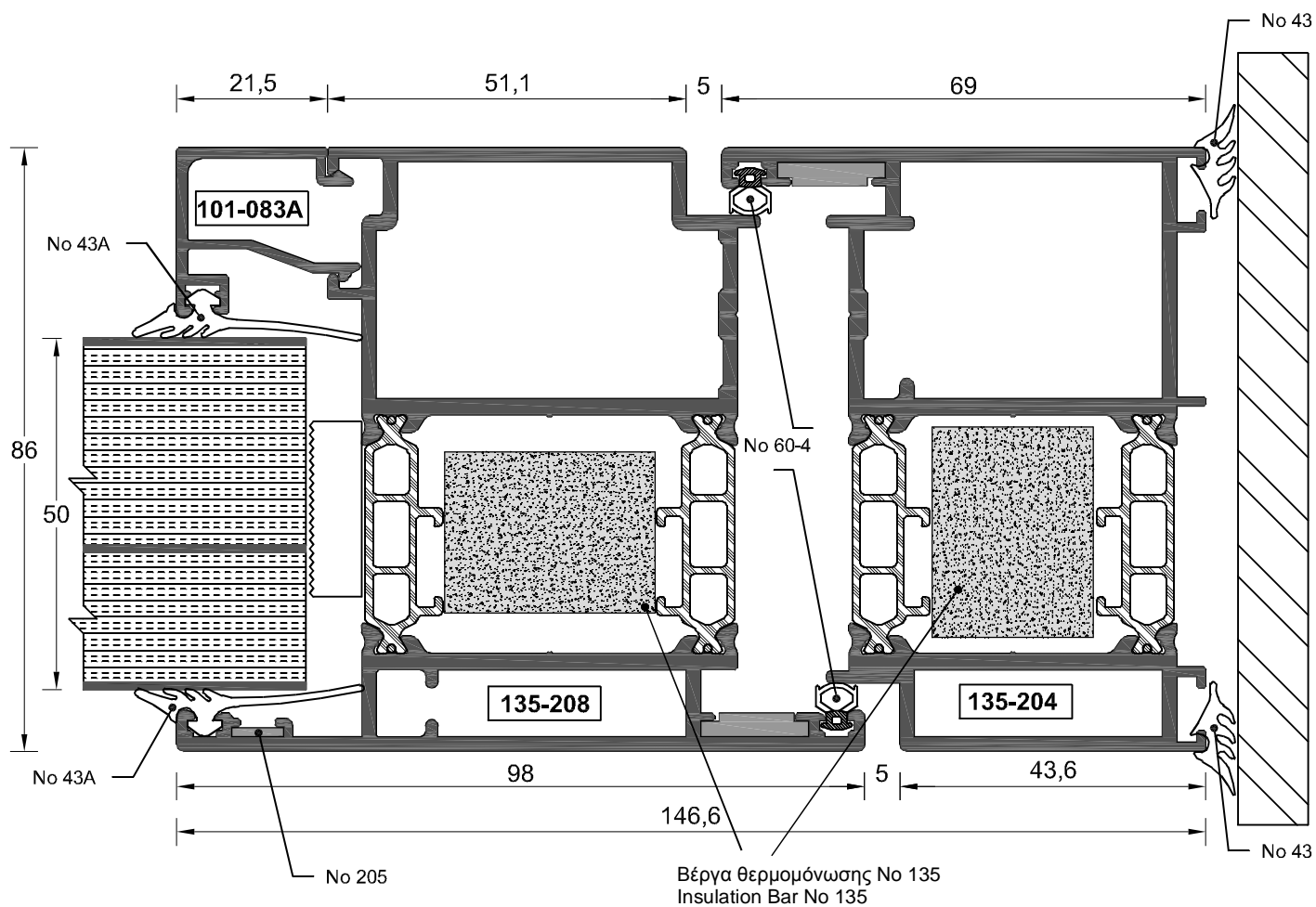

Κλίμακα / scale = 1 : 1

ΕΙΣΟΔΟΣ ΜΟΝΟΦΥΛΛΗ ΑΝΟΙΓΟΜΕΝΗ ΠΡΟΣ ΤΑ ΕΞΩ (PANEL 60mm)
SINGLE-SASH OUTWARDS OPENING ENTRANCE

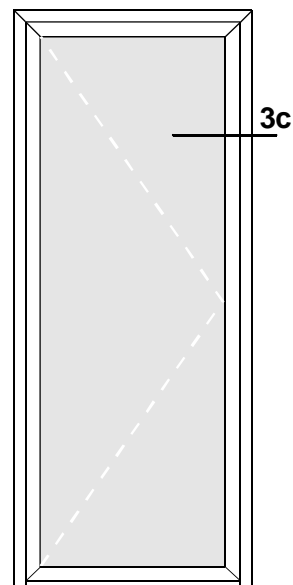

3c.

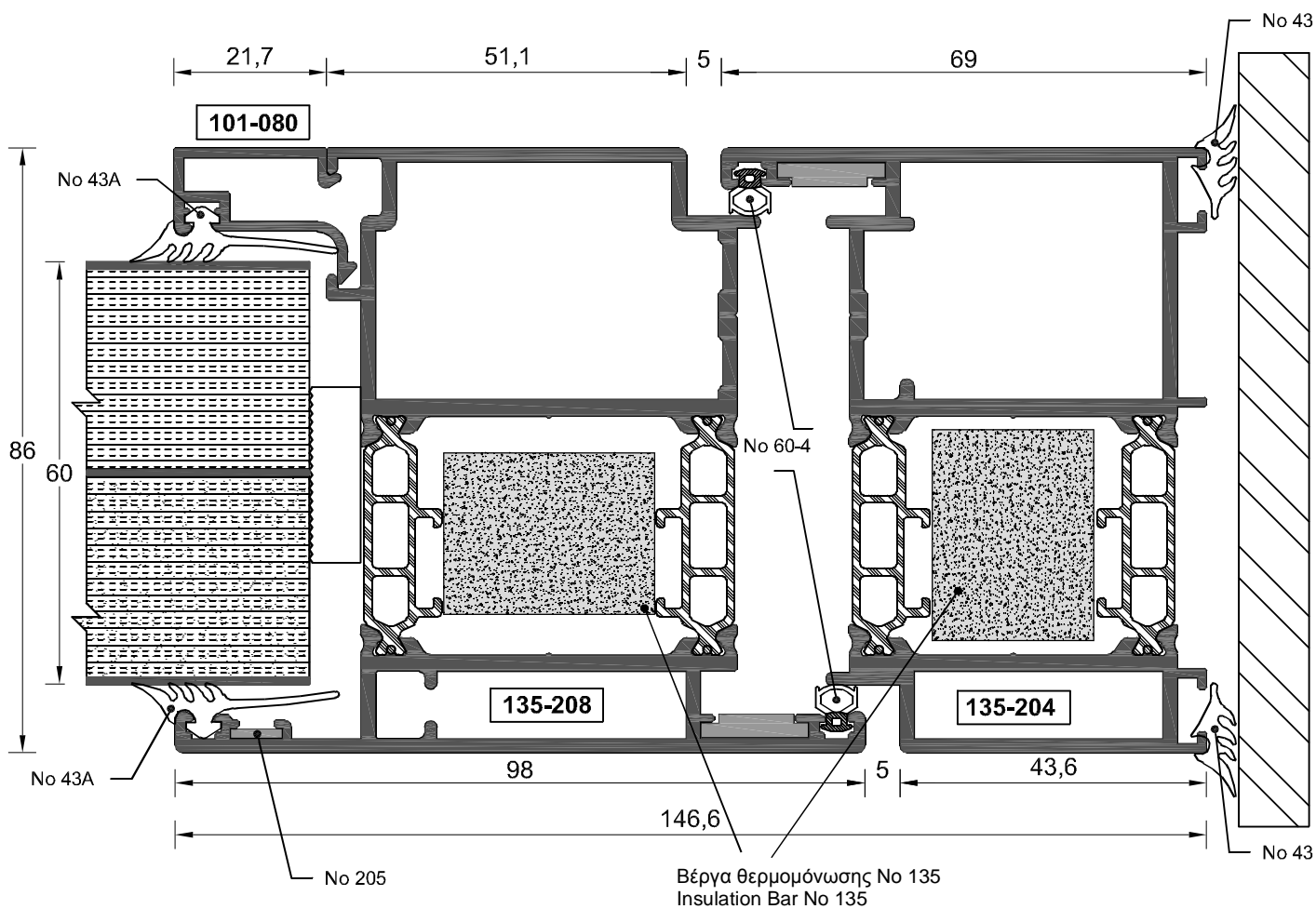

Κλίμακα / scale = 1 : 1

ΕΙΣΟΔΟΣ ΜΟΝΟΦΥΛΛΗ ΑΝΟΙΓΟΜΕΝΗ ΠΡΟΣ ΤΑ ΕΞΩ (PANEL 40mm)
SINGLE-SASH OUTWARDS OPENING ENTRANCE

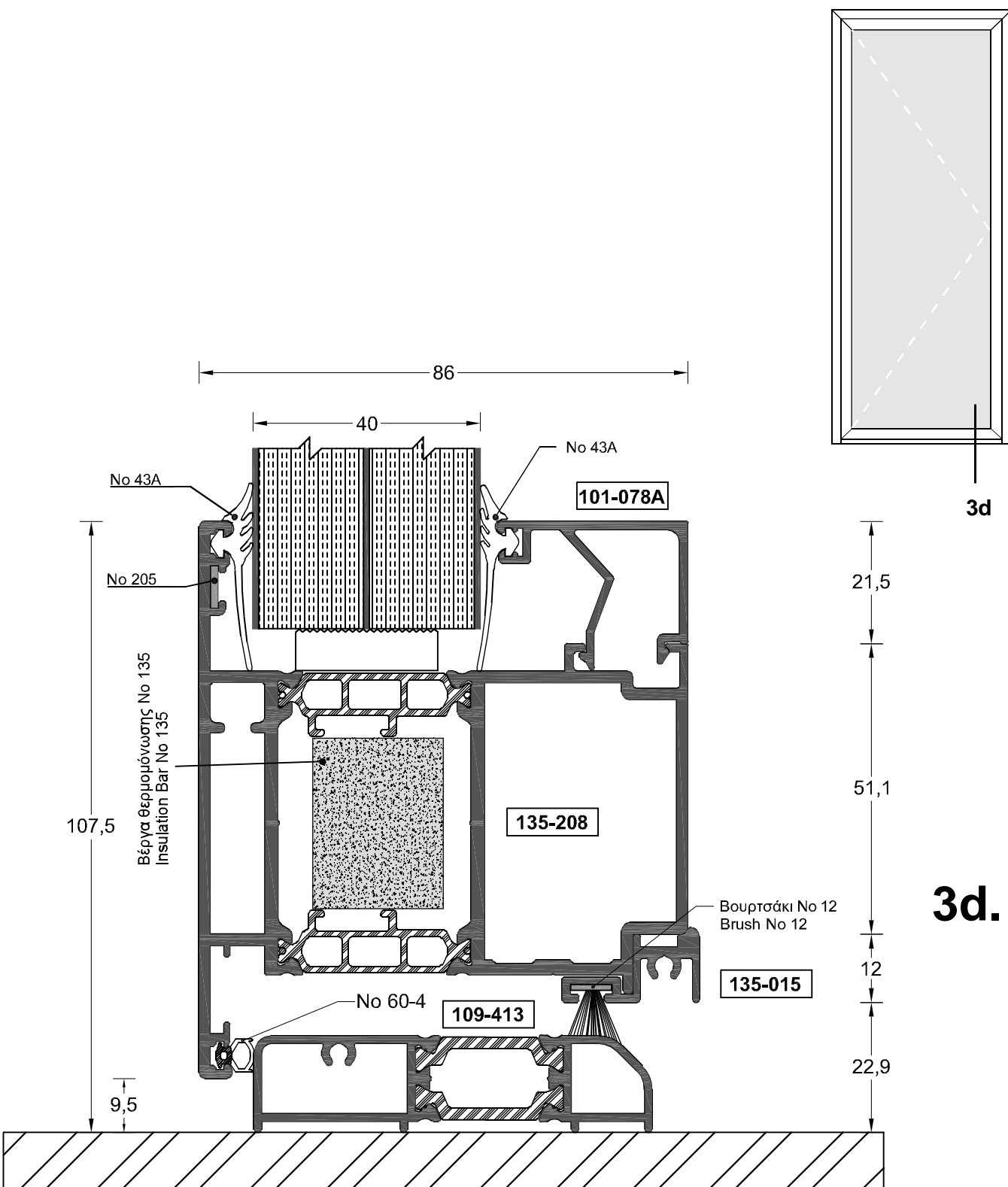

Κλίμακα / scale = 1 : 1

**ΕΙΣΟΔΟΣ ΔΙΦΥΛΛΗ ΑΝΟΙΓΟΜΕΝΗ ΠΡΟΣ
ΤΑ ΕΞΩ (PANEL 40mm)
DOUBLE-SASH OUTWARDS OPENING ENTRANCE**

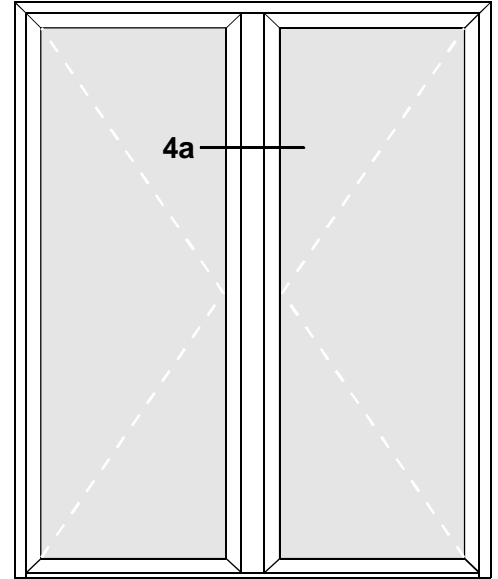
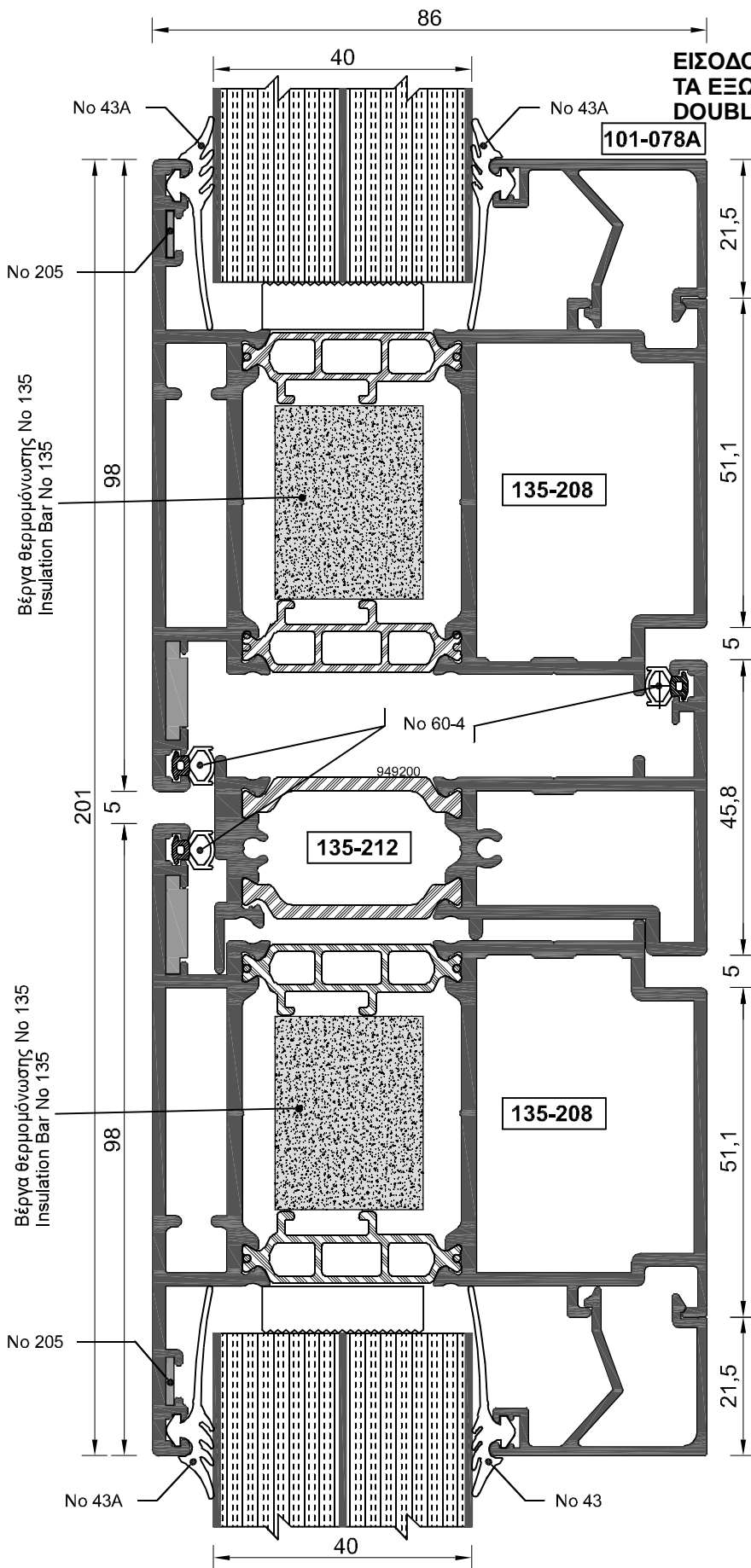

4a.

Κλίμακα / scale = 1 : 1

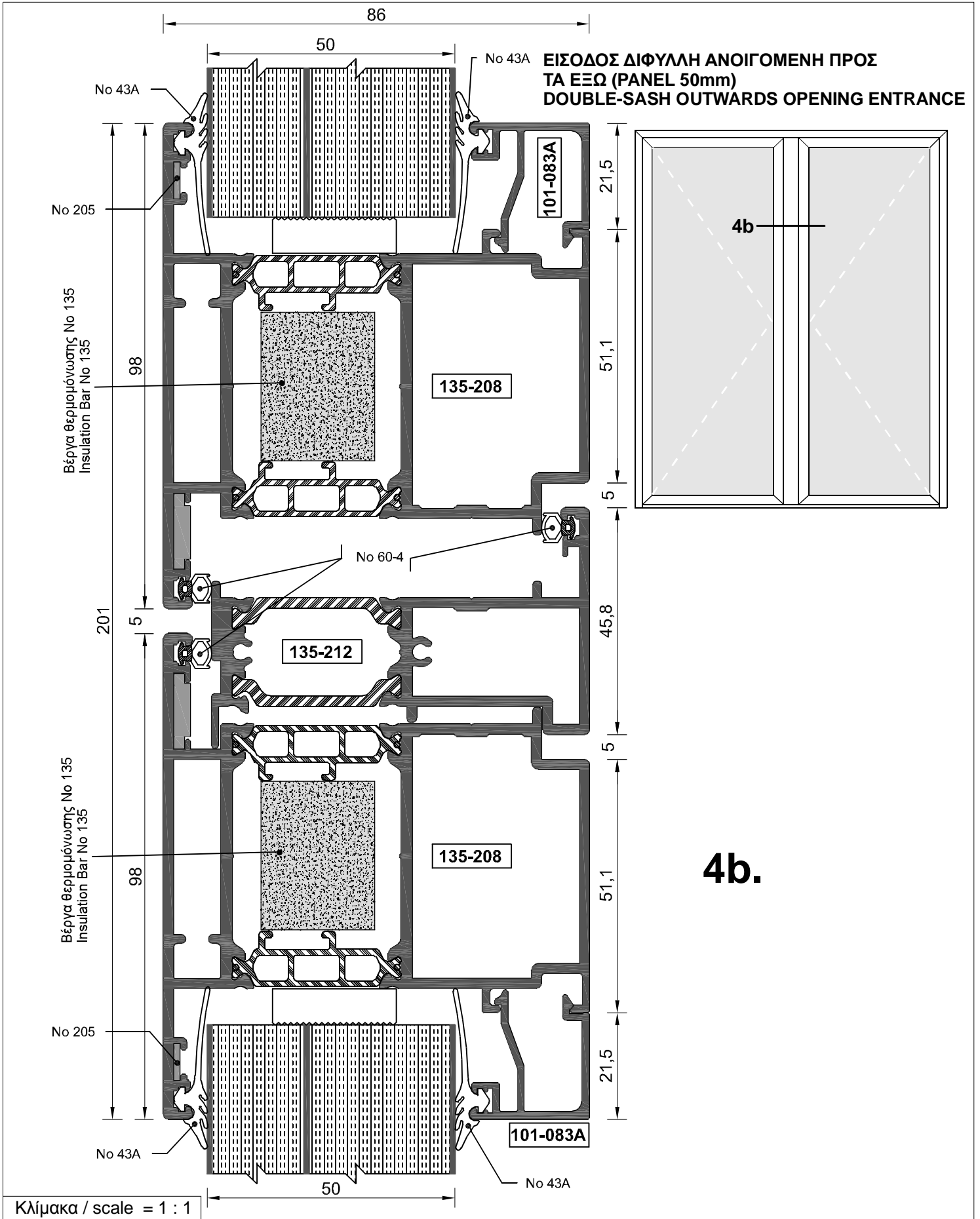

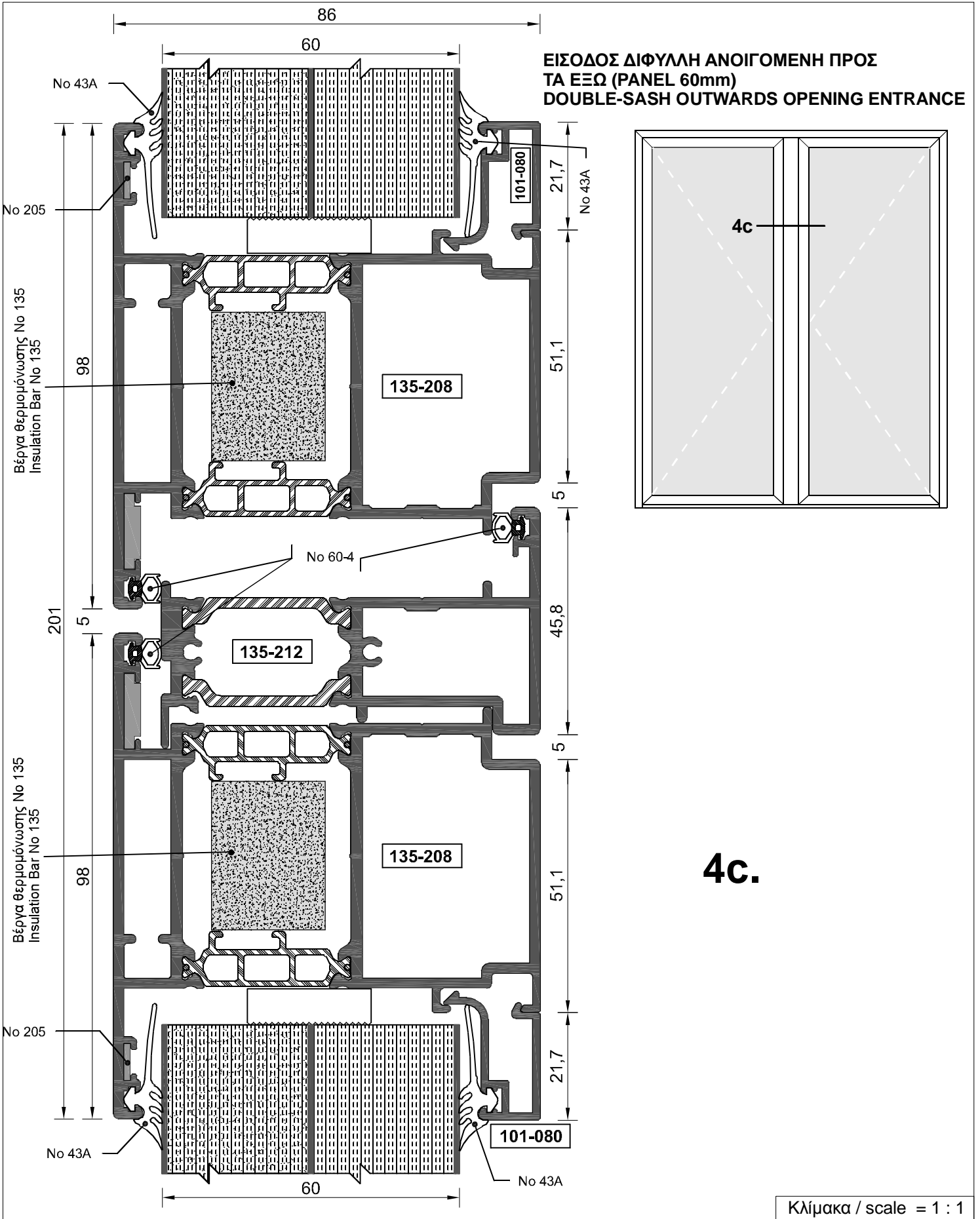

ΕΙΣΟΔΟΣ ΜΟΝΟΦΥΛΛΗ ΑΝΟΙΓΟΜΕΝΗ ΠΡΟΣ ΤΑ ΜΕΣΑ (PANEL 47mm)
SINGLE-SASH INWARDS OPENING ENTRANCE

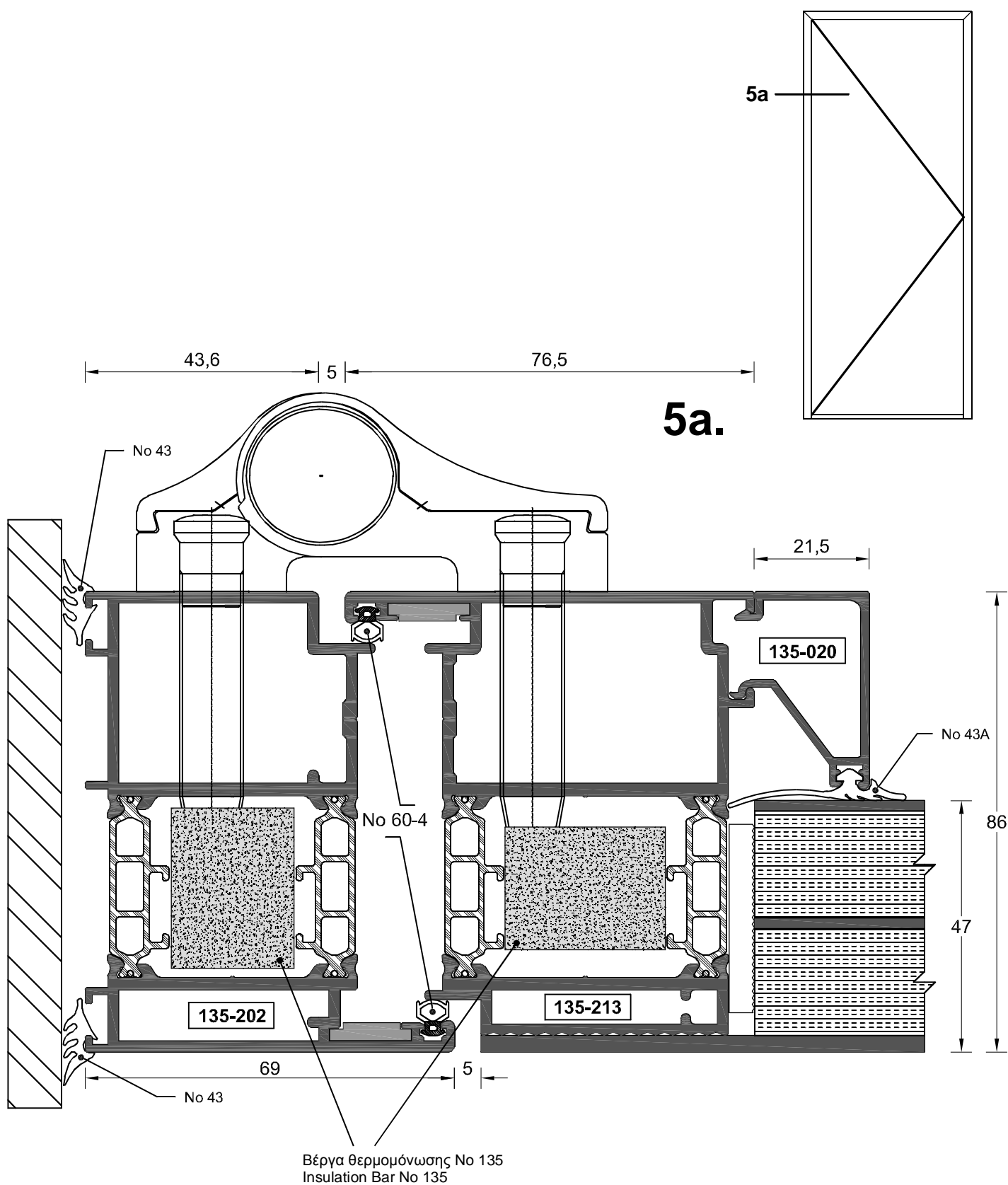

Κλίμακα / scale = 1 : 1

ΕΙΣΟΔΟΣ ΜΟΝΟΦΥΛΛΗ ΑΝΟΙΓΟΜΕΝΗ ΠΡΟΣ ΤΑ ΜΕΣΑ (PANEL 47mm)
SINGLE-SASH INWARDS OPENING ENTRANCE

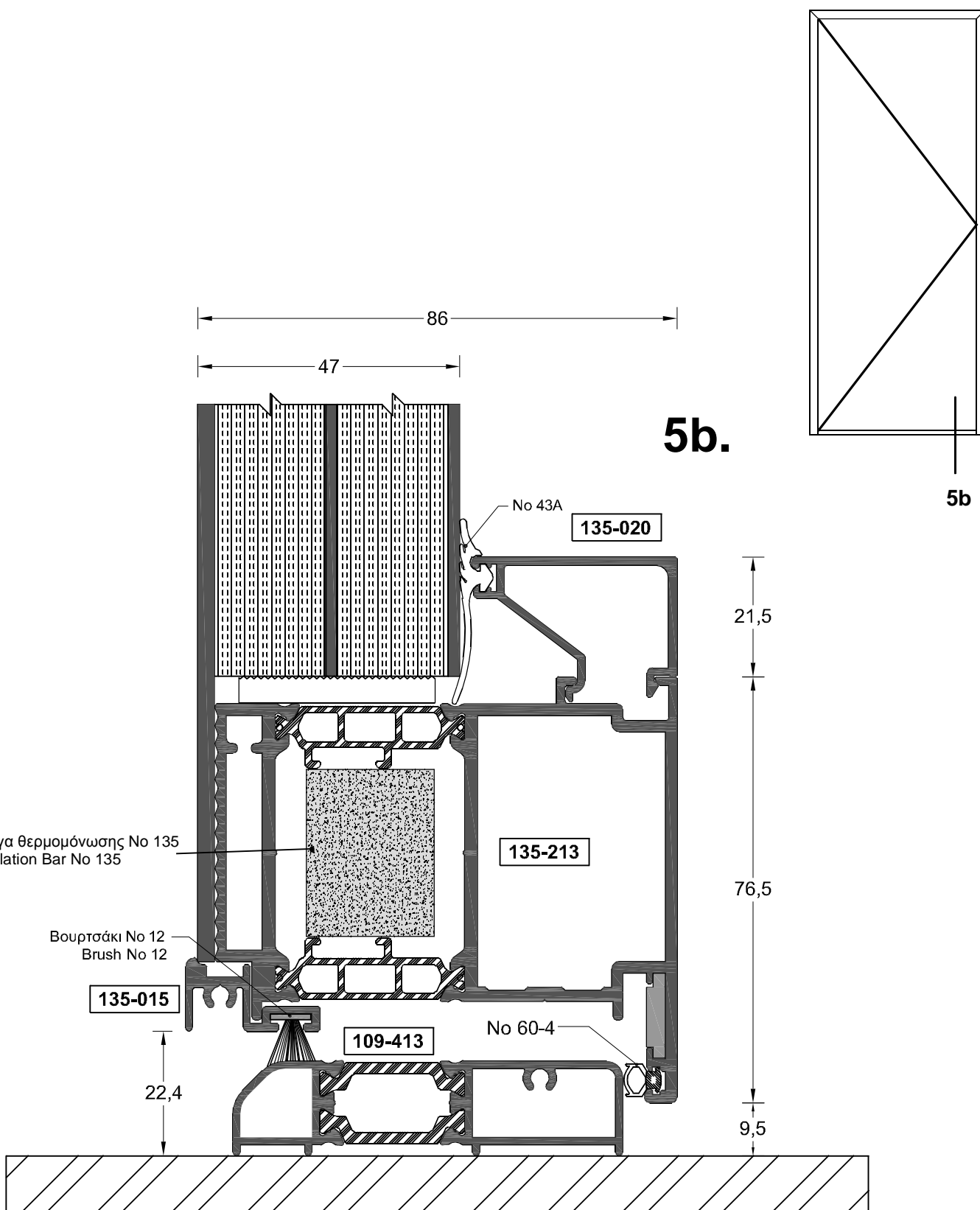

Κλίμακα / scale = 1 : 1

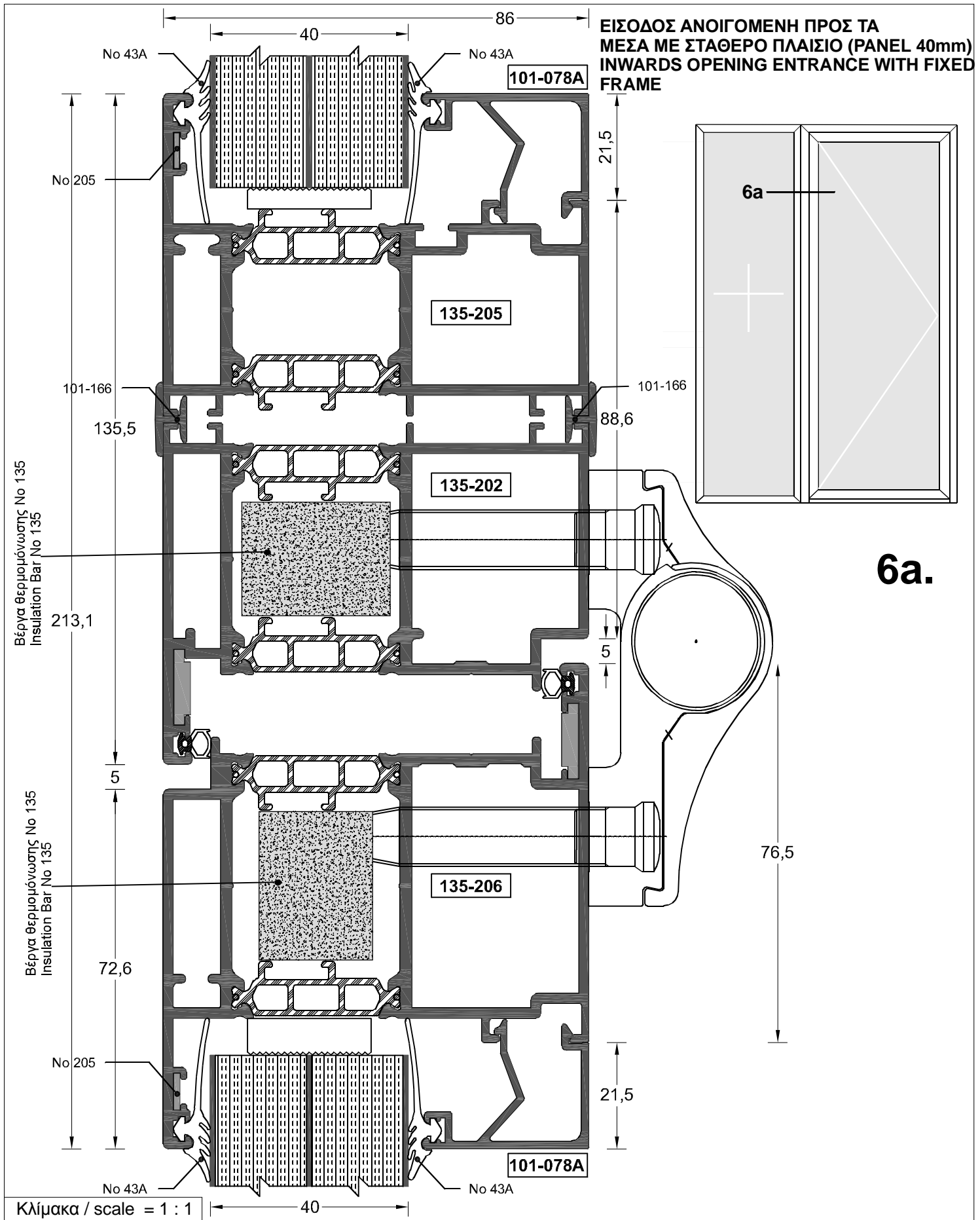

ΕΙΣΟΔΟΣ ΑΝΟΙΓΟΜΕΝΗ ΠΡΟΣ ΤΑ ΜΕΣΑ ΜΕ ΣΤΑΘΕΡΟ ΠΛΑΙΣΙΟ (PANEL 40mm)
INWARDS OPENING ENTRANCE WITH FIXED FRAME

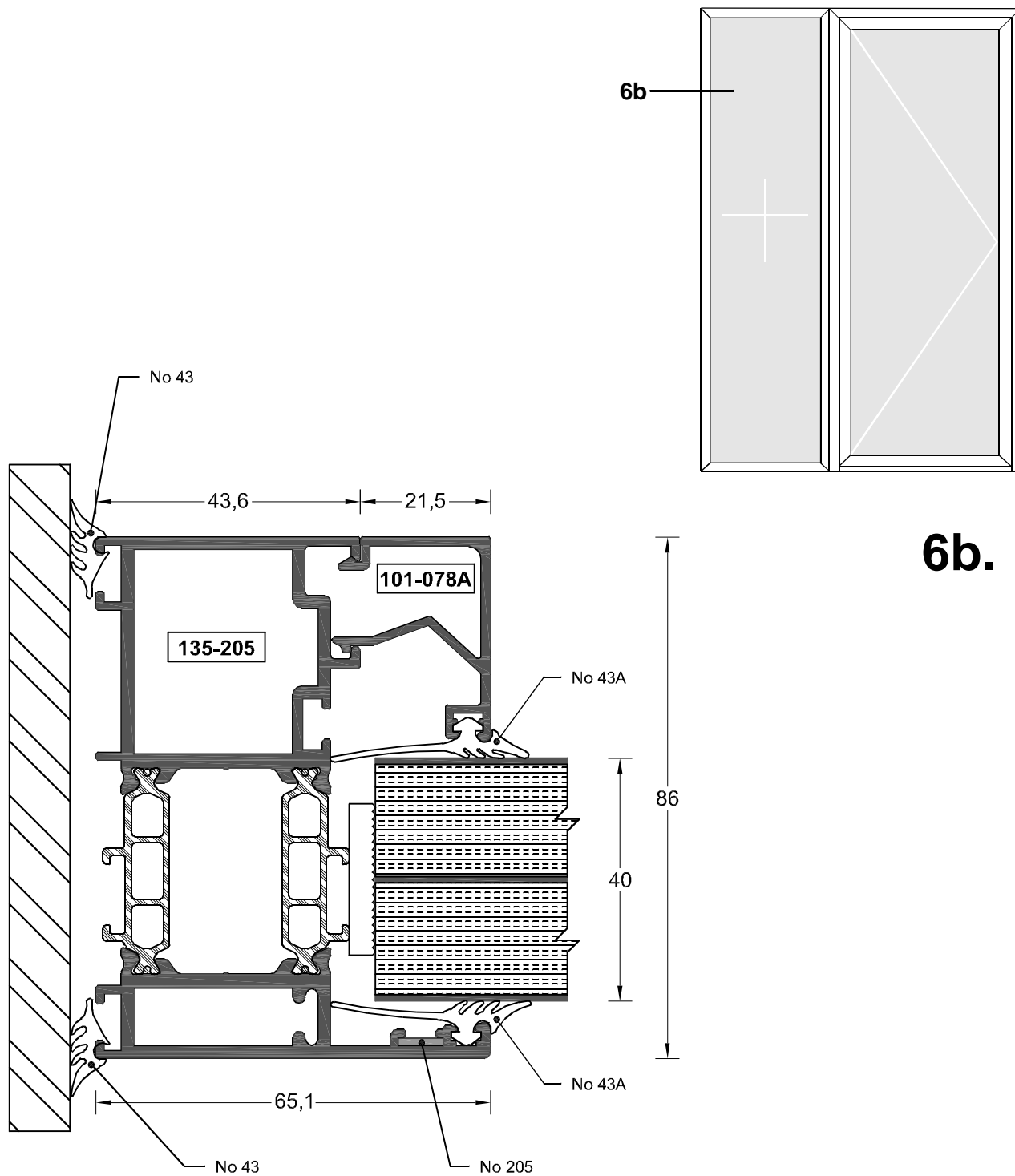

Κλίμακα / scale = 1 : 1

ΧΩΡΙΣΜΑ ΦΥΛΛΟΥ ΜΕ ΠΑΝΕΛ 40mm
SASH PARTITION WITH PANEL 40mm

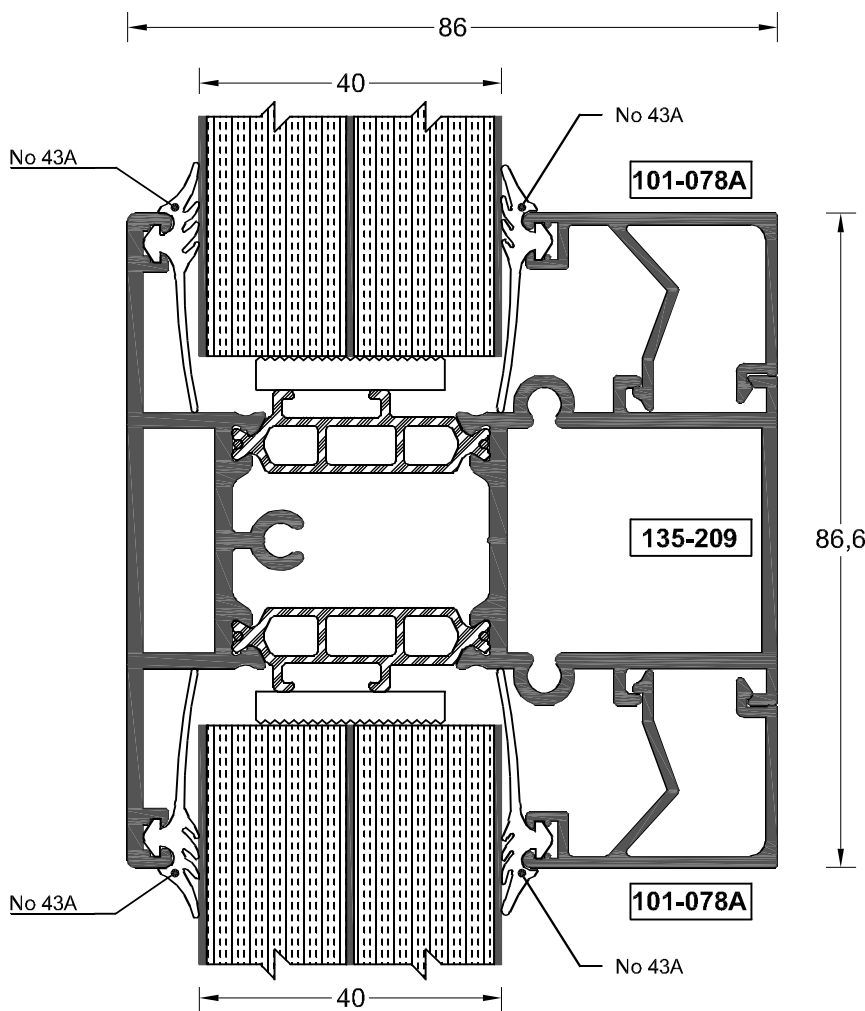
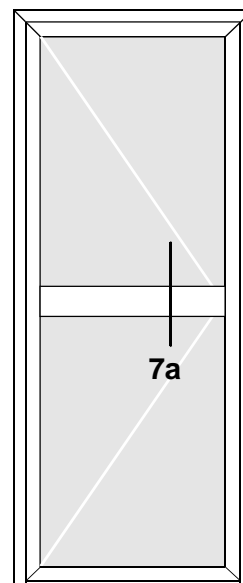

7a.

Κλίμακα / scale = 1 : 1

ΧΩΡΙΣΜΑ ΚΑΣΑΣ
FRAME PARTITION

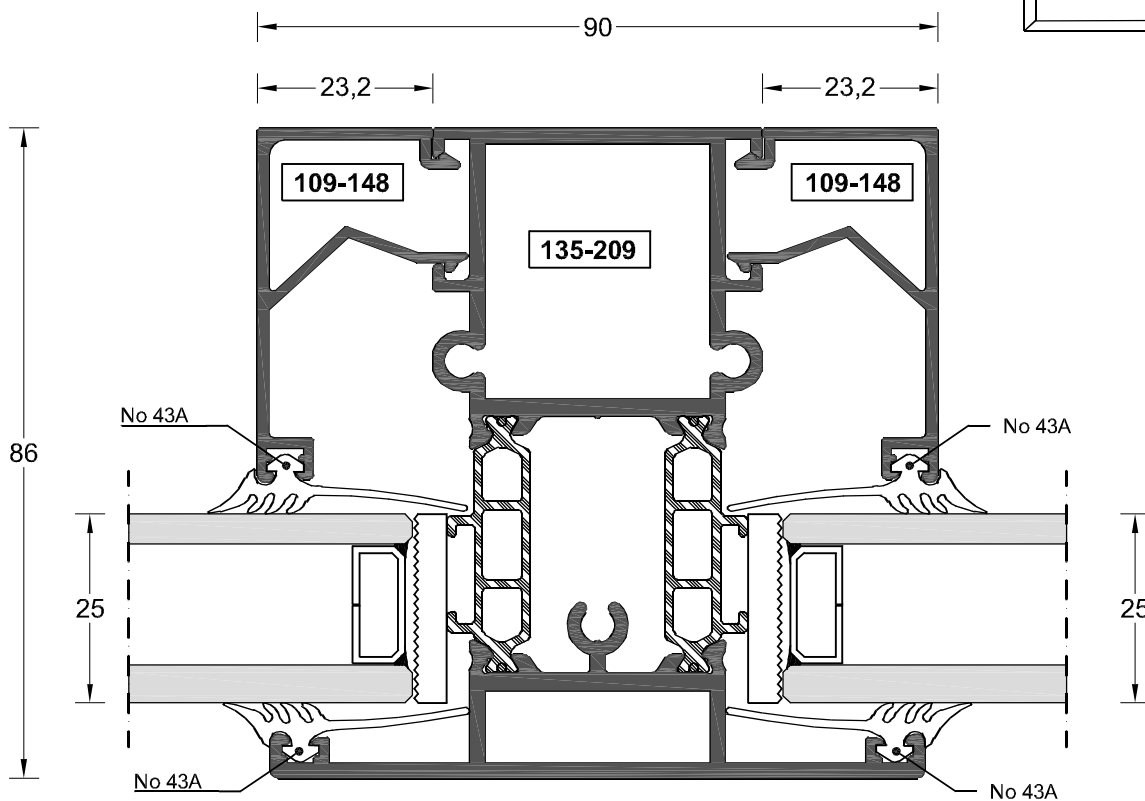
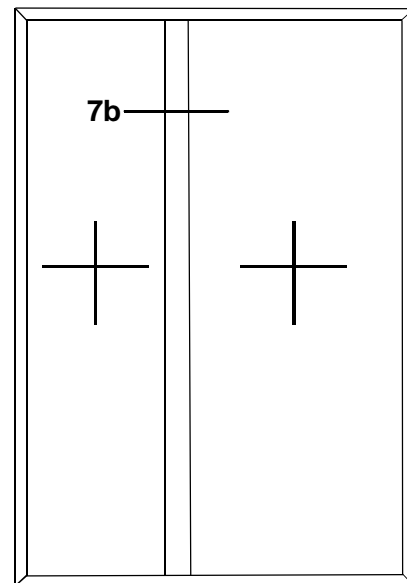

7b.

Κλίμακα / scale = 1 : 1

ΑΡΜΟΚΑΛΥΠΤΡΟ
Cover Gap

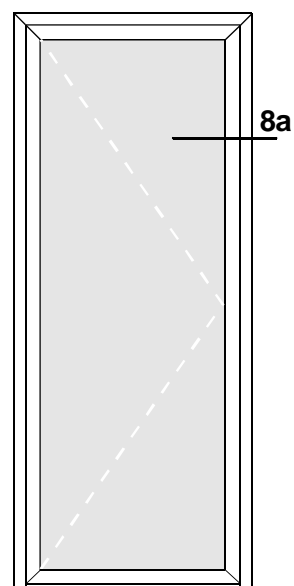

8a.

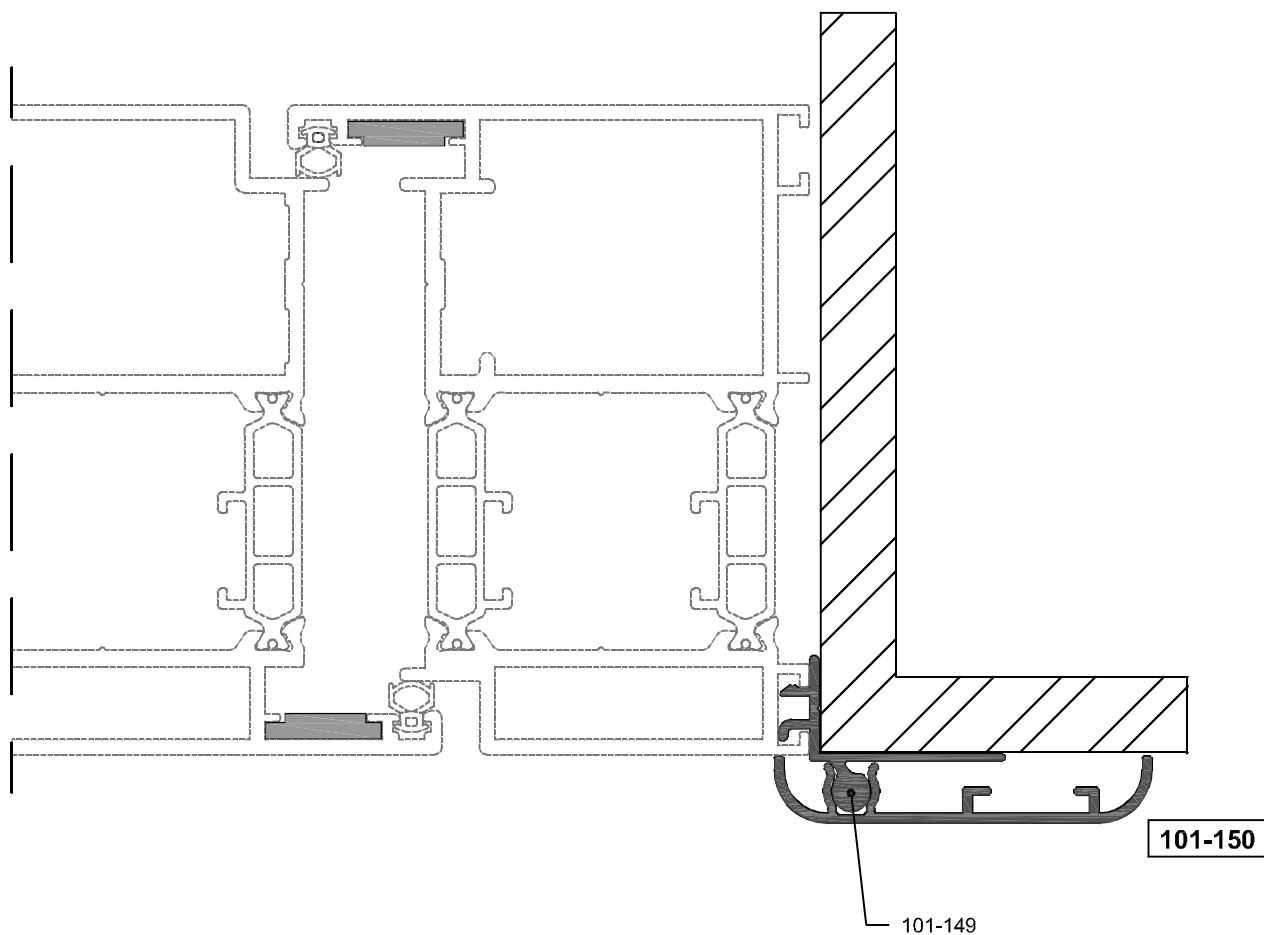

Κλίμακα / scale = 1 : 1

ΣΥΝΔΥΑΣΜΟΣ ΔΥΟ ΣΤΑΘΕΡΩΝ ΥΠΟ ΓΩΝΙΑ 90°
 COMBINATION OF TWO FIXED FRAMES FORMING ANGLE 90°

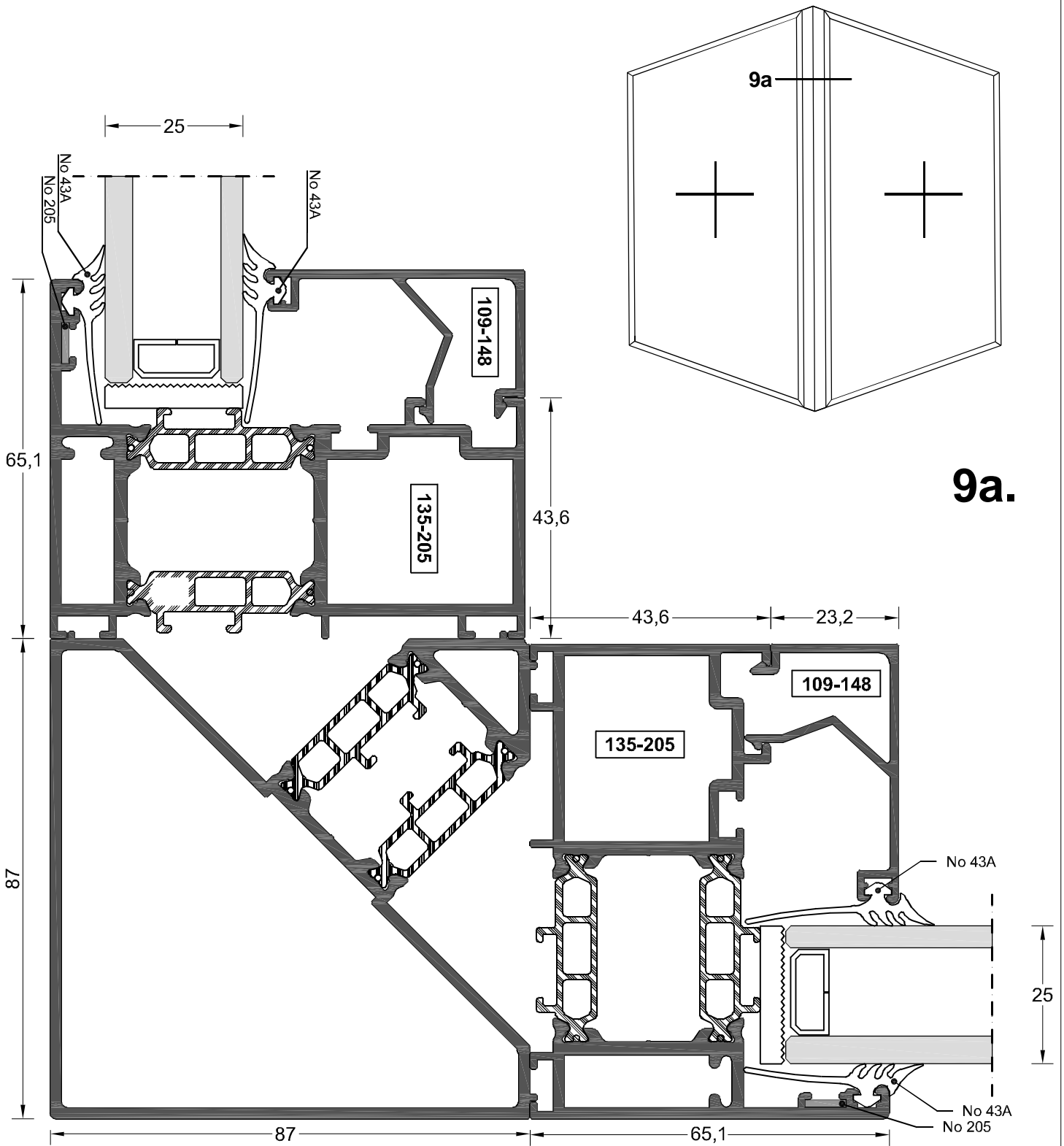

Κλίμακα / scale = 1 : 1

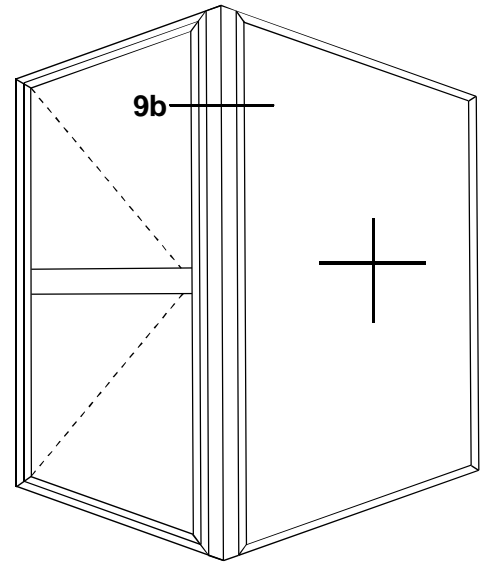
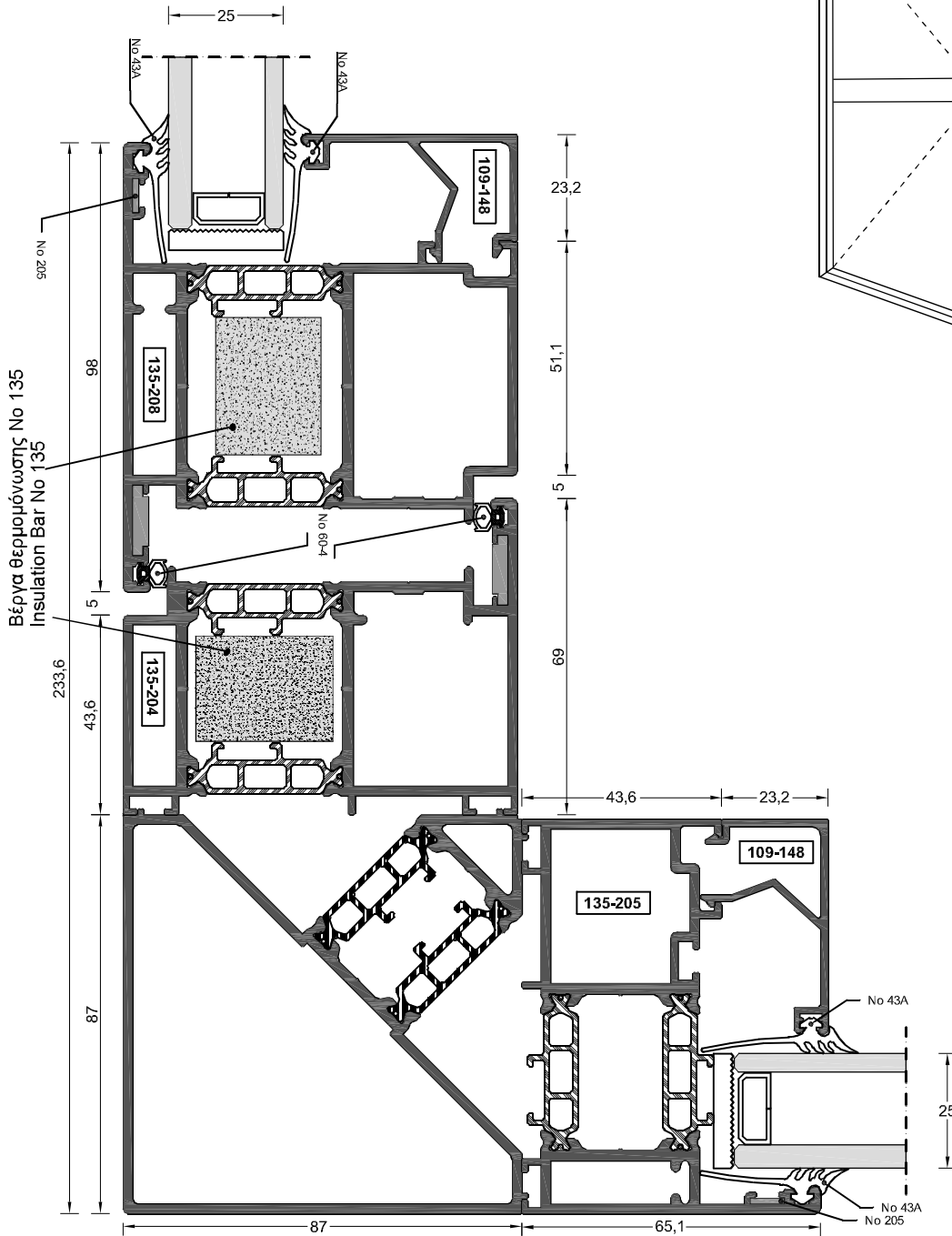

ΣΥΝΔΥΑΣΜΟΣ ΑΝΟΙΓΟΜΕΝΗΣ ΚΥΡΙΑΣ ΕΙΣΙΟΔΟΥ ΜΕ ΣΤΑΘΕΡΟ ΥΠΟ ΓΩΝΙΑ 90°
COMBINATION OF OPENING MAIN ENTRANCE WITH FIXED FRAME FORMING ANGLE 90°
ΠΡΟΣΟΧΗ / CAUTION : ΚΛΙΜΑΚΑ / SCALE = 1 : 1,5





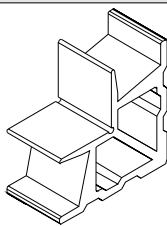
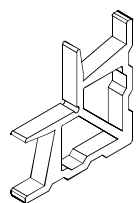
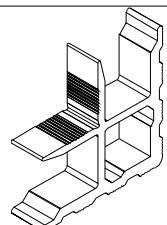
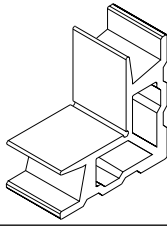
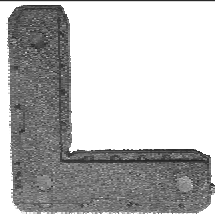

9b.

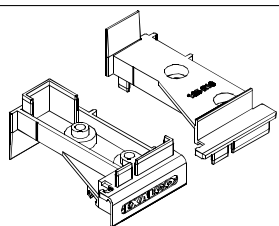
Κλίμακα / scale = 1 : 1,5

ΕΞΑΡΤΗΜΑΤΑ / ACCESSORIES

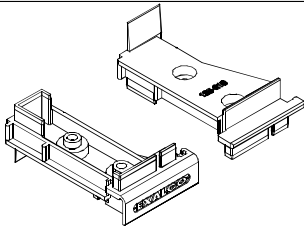
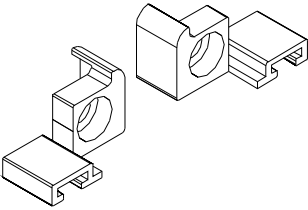
ΚΩΔΙΚΟΣ CODE	ΠΕΡΙΓΡΑΦΗ	DESCRIPTION	ΣΧΗΜΑ FIGURE
4349	ΓΩΝΙΑ ΓΩΝΙΑΣΤΡΑΣ 135-001	Extruded aluminium press corner 135-001	 33,0 mm
	ΓΙΑ ΤΑ ΠΡΟΦΙΛ / For profiles: 135-202, 135-204		
4350	ΓΩΝΙΑ ΓΩΝΙΑΣΤΡΑΣ 135-002	Extruded aluminium press corner 135-002	 8,8 mm
	ΓΙΑ ΤΑ ΠΡΟΦΙΛ / For profiles: 135-202, 135-204, 135-206, 135-208		
4351	ΓΩΝΙΑ ΓΩΝΙΑΣΤΡΑΣ 135-005	Extruded aluminium press corner 135-005	 23,3 mm
	ΓΙΑ ΤΑ ΠΡΟΦΙΛ / For profiles: 108-004, 108-005, 108-044		
5755	ΓΩΝΙΑ ΓΩΝΙΑΣΤΡΑΣ 109-011	Extruded aluminium press corner 109-011	 33,2 mm
	ΓΙΑ ΤΟ ΠΡΟΦΙΛ / For profile: 135-205		
5046	ΠΛΑΣΤΙΚΗ ΓΩΝΙΑ ΕΥΘΥΓΡΑΜΜΙΣΗΣ 109	Plastic alignment square 109	
5681	ΓΩΝΙΑ ΕΥΘΥΓΡΑΜΜΙΣΗΣ No 205	Alignment square No 205	
0000	ΤΑΠΑ ΓΙΑ ΜΠΙΝΙ ΕΙΣΟΔΟΥ ΑΝΟΙΓΟΜΕΝΗ ΠΡΟΣ ΤΑ ΜΕΣΑ ΔΕΞΙΑ No 135-210	Rabbit sealing plug for right-inwards opening entrance No 135-210	

ΕΞΑΡΤΗΜΑΤΑ / ACCESSORIES

ΚΩΔΙΚΟΣ CODE	ΠΕΡΙΓΡΑΦΗ	DESCRIPTION	ΣΧΗΜΑ FIGURE
0000	ΤΑΠΑ ΓΙΑ ΜΠΙΝΙ ΕΙΣΟΔΟΥ ΑΝΟΙΓΟΜΕΝΗ ΠΡΟΣ ΤΑ ΜΕΣΑ ΑΡΙΣΤΕΡΑ No 135-210	Rabbit sealing plug for left-inwards opening entrance No 135-210	
0000	ΤΑΠΑ ΓΙΑ ΜΠΙΝΙ ΕΙΣΟΔΟΥ ΑΝΟΙΓΟΜΕΝΗ ΠΡΟΣ ΤΑ ΕΞΩ ΔΕΞΙΑ No 135-212	Rabbit sealing plug for right-outwards opening entrance No 135-212	
0000	ΤΑΠΑ ΓΙΑ ΜΠΙΝΙ ΕΙΣΟΔΟΥ ΑΝΟΙΓΟΜΕΝΗ ΠΡΟΣ ΤΑ ΕΞΩ ΑΡΙΣΤΕΡΑ No 135-212	Rabbit sealing plug for left-outwards opening entrance No 135-212	
4352	ΤΑΠΑ ΝΕΡΟΧΥΤΗ 135-015 (ΖΕΥΓΟΣ)	Plastic plug for profile 135-015 (Pair)	
5800	ΛΑΣΤΙΧΟ ΣΤΗΡΙΞΗΣ ΤΖΑΜΙΟΥ No 42 (EPDM)	Glazing gasket No 42 (EPDM)	
5800	ΛΑΣΤΙΧΟ ΣΤΗΡΙΞΗΣ ΤΖΑΜΙΟΥ No 43 (EPDM)	Glazing gasket No 43 (EPDM)	
5004	ΛΑΣΤΙΧΟ ΣΤΗΡΙΞΗΣ ΤΖΑΜΙΟΥ No 43A (EPDM)	Glazing gasket No 43A (EPDM)	

ΕΞΑΡΤΗΜΑΤΑ / ACCESSORIES

ΚΩΔΙΚΟΣ CODE	ΠΕΡΙΓΡΑΦΗ	DESCRIPTION	ΣΧΗΜΑ FIGURE
3595	ΛΑΣΤΙΧΟ Νο 60-4 (EPDM)	GasketNo 42 (EPDM)	
5230	ΒΟΥΡΤΣΑΚΙ ΣΤΕΓΑΝΩΣΗΣ No12	Strip brush No12	
	ΜΕΝΤΕΣΕΣ ΒΑΡΕΩΣ ΤΥΠΟΥ 135 (Fapim)	Heavy-duty hinge 135 (fapim)	
4361	ΛΕΥΚΟΣ	White	
4362	ΜΑΥΡΟΣ	Black	
4363	ΑΣΗΜΙ	Silver	
4364	ΚΙΤ ΜΕ 4 ΒΙΔΕΣ (Fapim)	Mounting set for hinge (Fapim)	
4365	ΠΥΡΟΣ ΑΣΦΑΛΕΙΑΣ	Safety pin	
5661	ΦΩΛΙΑ	Bolt strike	
4707	ΚΛΕΙΔΑΡΙΑ (GU)	Safety lock mechanism (GU)	

ΕΞΑΡΤΗΜΑΤΑ / ACCESSORIES

ΚΩΔΙΚΟΣ CODE	ΠΕΡΙΓΡΑΦΗ	DESCRIPTION	ΣΧΗΜΑ FIGURE
5586	ΚΥΛΙΝΔΡΟΣ 35 / 110 mm	Cylinder lock 35 / 105 mm	
5881	ΠΟΜΟΛΟ ΔΙΠΛΟ (Fapim) ΑΣΗΜΙ	Handle (Fapim) Silver	
5528	ΡΟΖΕΤΑ ΠΟΜΟΛΟΥ Fapim ΑΣΗΜΙ	Cover for cylinder (Fapim) Silver	
3959	ΒΙΔΕΣ ΑΥΤΟΔΙΑΤΡΗΤΕΣ 3,9 X 25	Self-drilled screw 3,9 X 25	
4708	ΜΕΣΑΙΟ ΚΥΠΡΙ ΑΥΤΟΜΑΤΟ SF ALU(GU) ΔΕΞΙΟ - ΑΡΙΣΤΕΡΟ	Stricking plate autom. SF ALU (GU) Left - Right	
4709	ΠΛΑΚΑΚΙ ΚΛΕΙΔΩΜΑΤΟΣ ΑΥΤΟΜΑΤΟ SF ALU(GU)	Locking plate autom. SF ALU (GU)	

ΜΕΤΡΑ ΚΟΠΗΣ (ΕΞΩΤΕΡΙΚΑ)
CUTTING DIMENSIONS (OUTER)

ΠΑΡΑΘΥΡΟ ΜΟΝΟΦΥΛΛΟ
 Single - sash window

ΥΨΟΣ ΦΥΛΛΟΥ Height of sash	$S = H - 58 \text{ mm}$
ΠΛΑΤΟΣ ΦΥΛΛΟΥ Width of sash	$W = L - 97 \text{ mm}$

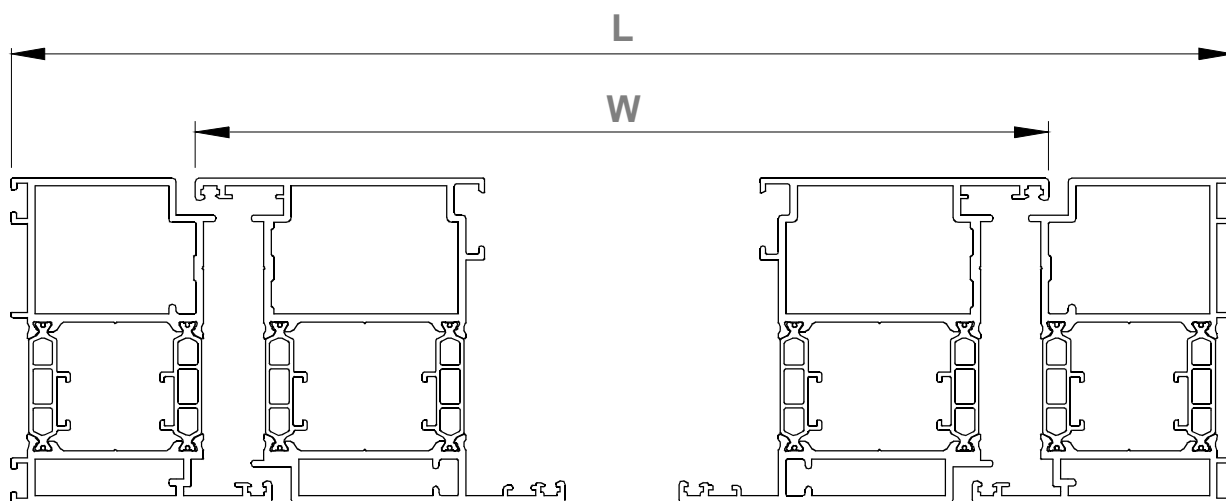
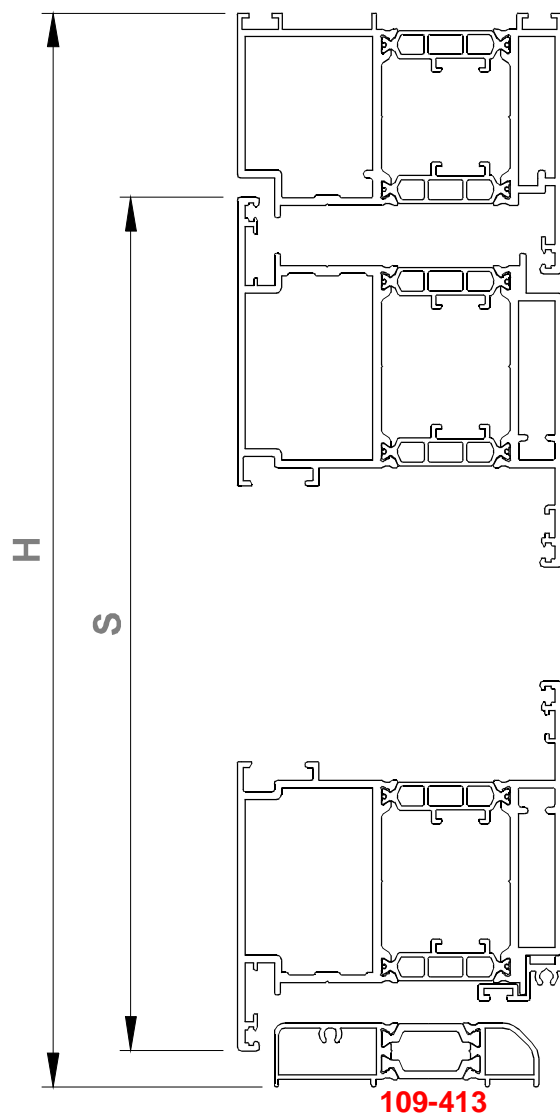

ΜΕΤΡΑ ΚΟΠΗΣ (ΕΞΩΤΕΡΙΚΑ)
CUTTING DIMENSIONS (OUTER)

ΠΑΡΑΘΥΡΟ ΔΙΦΥΛΛΟ
Double - sash window

ΥΨΟΣ ΦΥΛΛΟΥ Height of sash	$S = H - 58 \text{ mm}$
ΠΛΑΤΟΣ ΦΥΛΛΟΥ Width of sash	$W = \frac{L - 102}{2} \text{ mm}$

